

OMNIMATE Signal - series BL/SL 3.50
BL 3.50/08/90F SN OR BX

Weidmüller Interface GmbH & Co. KG
 Klingenbergstraße 16
 D-32758 Detmold
 Germany
 Fon: +49 5231 14-0
 Fax: +49 5231 14-292083
 www.weidmueller.com

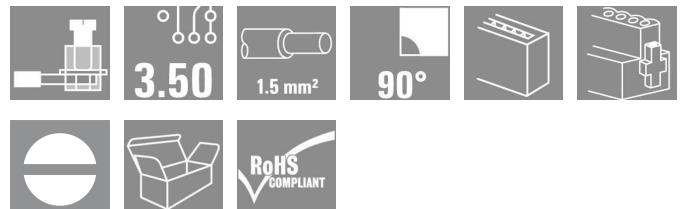

Female connectors with clamping yoke screw system for connecting conductors at 3.50 mm pitch. They provide space for labelling and can be coded.

General ordering data

Type	BL 3.50/08/90F SN OR BX
Order No.	1639070000
Version	PCB plug-in connector, female plug, 3.50 mm, No. of poles: 8, 90°, Clamping yoke connection, Clamping range, rated connection, max.: 1.5 mm², Box
GTIN (EAN)	4008190276614
Qty.	50 pc(s).
Product data	IEC: 320 V / 12 A / 0.2 - 1.5 mm² UL: 300 V / 8 A / AWG 28 - AWG 14
Packaging	Box

**OMNIMATE Signal - series BL/SL 3.50
BL 3.50/08/90F SN OR BX**

Weidmüller Interface GmbH & Co. KG
Klingenbergstraße 16
D-32758 Detmold
Germany
Fon: +49 5231 14-0
Fax: +49 5231 14-292083
www.weidmueller.com

Technical data**Dimensions and weights**

Net weight	8.66 g
------------	--------

System parameters

Product family	OMNIMATE Signal - series BL/SL 3.50	Wire connection method	Clamping yoke connection
Conductor outlet direction	90°	Pitch in mm (P)	3.5 mm
Pitch in inches (P)	0.138 inch	No. of poles	8
Plugging cycles	25	Screwdriver blade	0.4 x 2.5
Screwdriver blade standard	DIN 5264	Tightening torque, min.	0.2 Nm
Tightening torque, max.	0.25 Nm	Tightening torque for screw flange, min.	0.2 Nm
Tightening torque for screw flange, max.	0.25 Nm	Clamping screw	M 2
Stripping length	6 mm	L1 in mm	24.5 mm
L1 in inches	0.965 inch	Touch-safe protection acc. to DIN VDE 0470	IP 20
Touch-safe protection acc. to DIN VDE 57 106	Safe from finger touch	Clearance, min.	4.2 mm
Creepage distance, min.	4.2 mm		

Material data

Insulating material	PBT	Moisture Level (MSL)	3
Colour	Orange	Colour chart (similar)	RAL 2000
UL 94 flammability rating	V-0	CTI	≥ 200
Contact material	Cu-Leg	Contact surface	tinned
Operating temperature, min.	-50 °C	Operating temperature, max.	100 °C
Temperature range, installation, min.	-30 °C	Temperature range, installation, max.	100 °C

Connectable conductors

Clamping range, rated connection, min.	0.08 mm ²	Clamping range, rated connection, max.	1.5 mm ²
Wire connection cross section AWG, min.	AWG 28	Wire connection cross section AWG, max.	AWG 14
Solid, min. H05(07) V-U	0.2 mm ²	Solid, max. H05(07) V-U	1.5 mm ²
Flexible, min. H05(07) V-K	0.2 mm ²	Flexible, max. H05(07) V-K	1.5 mm ²
w. wire end ferrule, DIN 46228 pt 1, min.	0.2 mm ²	w. wire end ferrule, DIN 46228 pt 1, max.	1.5 mm ²
w. plastic collar ferrule, DIN 46228 pt 4, min.	0.2 mm ²	w. plastic collar ferrule, DIN 46228 pt 4, max.	1.5 mm ²
Plug gauge acc. to EN 60999 a x b; Ø	2.4 mm x 1.5 mm		

Rating data acc. to IEC 60664-1 / IEC 61984

Rated current, min. no. of poles (Tu=20°C)	12 A	Rated current, max. no. of poles (Tu=20°C)	10 A
Rated current, number of poles (Tu=40°C), min	10 A	Rated current, number of poles (Tu=40°C), max.	8 A
Rated voltage for surge voltage class / pollution degree II/2	320 V	Rated voltage for surge voltage class / pollution degree III/2	160 V
Rated voltage for surge voltage class / pollution degree III/3	160 V	Rated impulse voltage for surge voltage class/ pollution degree II/2	2.5 kV
Rated impulse voltage for surge voltage class/ pollution degree III/2	2.5 kV	Rated impulse voltage for surge voltage class/ contamination degree III/3	2.5 kV
Short-time withstand current resistance	3 x 1s with 100 A		

Data sheet

**OMNIMATE Signal - series BL/SL 3.50
BL 3.50/08/90F SN OR BX**

Weidmüller Interface GmbH & Co. KG
Klingenbergstraße 16
D-32758 Detmold
Germany
Fon: +49 5231 14-0
Fax: +49 5231 14-292083
www.weidmueller.com

Technical data

CSA rating data

Institute (CSA)		Certificate No. (CSA)	
		154685-1318353	
Rated voltage (Use group B)	300 V	Rated current (use group B)	10 A
Rated voltage (use group D)	300 V	Rated current (use group D)	10 A
Wire cross-section, AWG, min.	AWG 28	Wire cross-section, AWG, max.	AWG 14

UL 1059 rating data

Institute (UR)		Certificate No. (UR)	
		E60693	
Rated voltage (use group B)	300 V	Rated current (use group B)	8 A
Rated voltage (use group D)	300 V	Rated current (use group D)	8 A
Wire cross-section, AWG, min.	AWG 28	Wire cross-section, AWG, max.	AWG 14

Classifications

ETIM 3.0	EC001284	ETIM 4.0	EC002637
ETIM 5.0	EC002637	ETIM 6.0	EC002637
UNSPSC	30-21-18-10	eClass 5.1	27-26-07-04
eClass 6.2	27-26-07-04	eClass 7.1	27-44-04-02

Notes

- Notes
- Additional colours on request
 - Gold-plated contact surfaces on request
 - Rated current related to rated cross-section & min. No. of poles.
 - Max. outer diameter of the conductor: 2.9 mm
 - Wire end ferrule without plastic collar to DIN 46228/1
 - Wire end ferrule with plastic collar to DIN 46228/4
 - P on drawing = pitch
 - Rated data refer only to the component itself. Clearance and creepage distances to other components are to be designed in accordance with the relevant application standards.

IPC conformity The products are developed, manufactured and delivered according to the internationally recognised IPC-A-610 standard, category "permissible". More extensive demands on the products can be evaluated on request.

Approvals



ROHS Conform

**OMNIMATE Signal - series BL/SL 3.50
BL 3.50/08/90F SN OR BX**

Weidmüller Interface GmbH & Co. KG
Klingenbergstraße 16
D-32758 Detmold
Germany
Fon: +49 5231 14-0
Fax: +49 5231 14-292083
www.weidmueller.com

Drawings

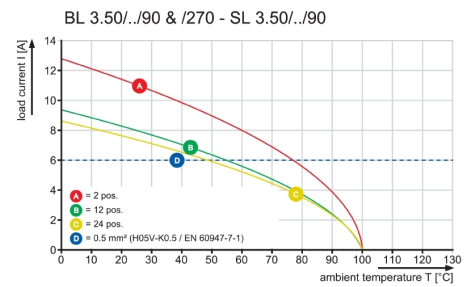
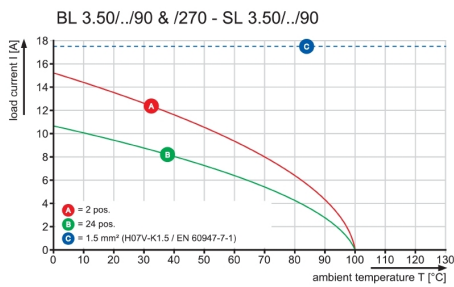
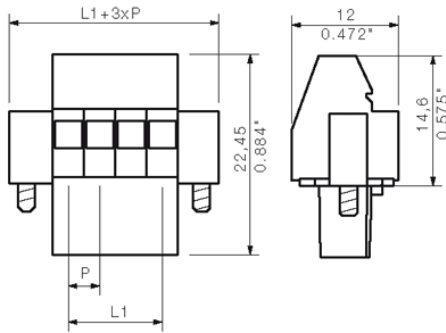

**OMNIMATE Signal - series BL/SL 3.50
BL 3.50/08/90F SN OR BX**

Weidmüller Interface GmbH & Co. KG
Klingenbergstraße 16
D-32758 Detmold
Germany
Fon: +49 5231 14-0
Fax: +49 5231 14-292083
www.weidmueller.com

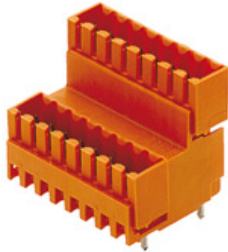
Mating connector (conditionally pluggable)
SLD 3.50V/180G

Double-level, staggered pin header for wave soldering at 3.50 mm pitch. They are available in closed and flanged versions. The male connectors provide space for labelling and can be coded.

General ordering data

Type	Order No.	Version	GTIN (EAN)	Qty.	Product data	Packaging
SLD	1641140000	PCB plug-in connector, male header, closed side, Solder connection, 3.50 mm, No. of poles: 16, 180°, Solder pin length (l): 3.2 mm, tinned, Orange, Box	4008190279547	20 pc(s).	IEC: 200 V / 10.5 A UL: 300 V / 8 A	Box

SL-SMT 3.5/90G Box

High-temperature-resistant male header, 3.50 mm pitch.

- **Plugging direction parallel (90°), straight 180° or angled (135°) to PCB**
- **Housing variants: closed side (G), screw flange (F), solder flange (LF) or snap-on solder flange (RF)**
- **Optimised for the SMT process**
- **Pin length 3.2 mm universal for all soldering methods**
- **Pin length 1.5 mm optimised for reflow soldering methods**
- **Packed either in a box (BX) or tape-on-reel (RL)**
- **Male header can be coded**

General ordering data

Type	Order No.	Version	GTIN (EAN)	Qty.	Product data	Packaging
SL-SMT	1841690000	PCB plug-in connector, male header, closed side, Reflow solder connection, 3.50 mm, No. of poles: 8, 90°, Solder pin length (l): 3.2 mm, tinned, Black, Box	4032248353040	50 pc(s).	IEC: 320 V / 15 A UL: 300 V / 10 A	Box
SL-SMT	1761602001	PCB plug-in connector, male header, closed side, Reflow solder connection, 3.50 mm, No. of poles: 8, 90°	4032248132096	50 pc(s).	IEC: 320 V / 15 A UL: 300 V / 10 A	Box

OMNIMATE Signal - series BL/SL 3.50 BL 3.50/08/90F SN OR BX

Weidmüller Interface GmbH & Co. KG
 Klingenbergstraße 16
 D-32758 Detmold
 Germany
 Fon: +49 5231 14-0
 Fax: +49 5231 14-292083
 www.weidmueller.com

Mating connector (conditionally pluggable)

Solder pin length (l): 1.5 mm, tinned, Black, Box

SLD 3.50V/90G



Double-level, staggered pin header for wave soldering at 3.50 mm pitch. They are available in closed and flanged versions. The male connectors provide space for labelling and can be coded.

General ordering data

Type	Order No.	Version	GTIN (EAN)	Qty.	Product data	Packaging
SLD	1642270000	PCB plug-in connector, male	4008190280796	20 pc(s).	IEC: 200 V / 10.5 A	Box
3.50V/16/90G		header, closed side, Solder connection, 3.50 mm, No. of poles: 16, 90°, Solder pin length (l): 3.2 mm, tinned, Orange, Box			UL: 300 V / 8 A	

SL-THR 3.5/135F



High-temperature-resistant male header, 3.50 mm pitch.

- **Plugging direction parallel (90°), straight 180° or angled (135°) to PCB**
- **Housing variants: closed side (G), screw flange (F), solder flange (LF) or snap-on solder flange (RF)**
- **Optimised for the SMT process**
- **Pin length 3.2 mm universal for all soldering methods**
- **Pin length 1.5 mm optimised for reflow soldering methods**
- **Packed either in a box (BX) or tape-on-reel (RL)**
- **Male header can be coded**

General ordering data

Type	Order No.	Version	GTIN (EAN)	Qty.	Product data	Packaging
SL-SMT	1003570000	PCB plug-in connector, male	4032248700196	50 pc(s).	IEC: 320 V / 15 A	Box
3.50/08/135F		header, Flange, Reflow solder connection, 3.50 mm, No. of poles: 8, 135°, Solder pin length (l): 3.2 mm, tinned, Black, Box			UL: 300 V / 10 A	

**OMNIMATE Signal - series BL/SL 3.50
BL 3.50/08/90F SN OR BX**

Weidmüller Interface GmbH & Co. KG
Klingenbergstraße 16
D-32758 Detmold
Germany
Fon: +49 5231 14-0
Fax: +49 5231 14-292083
www.weidmueller.com

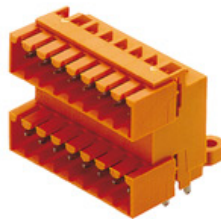
Mating connector (conditionally pluggable)
SLD 3.50/90G

Two-tier pin header for wave soldering in 3.50 mm pitch. The connector is available in open, closed and flange versions. The male connectors provide space for labelling and can be coded. Packed in a cardboard box.

General ordering data

Type	Order No.	Version	GTIN (EAN)	Qty.	Product data	Packaging
SLD	1633640000	PCB plug-in connector, male	4008190258092	20 pc(s).	IEC: 200 V / 10.5 A UL: 300 V / 8 A	Box
3.50/16/90G		header, closed side, Solder connection, 3.50 mm, No. of poles: 16, 90°, Solder pin length (l): 3.2 mm, tinned, Orange, Box				
3.2SN OR BX						

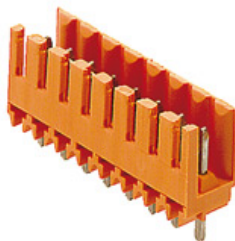
SL 3.50/180

Pin headers for wave soldering in 3.50 mm pitch

- Plugging direction is parallel (90°), straight 180° or angled (135°) to the PCB
- Housing variant: screw flange (F)
- Packed in a cardboard box (BX)
- Pin header can be coded

General ordering data

Type	Order No.	Version	GTIN (EAN)	Qty.	Product data	Packaging
SL	1604830000	PCB plug-in connector, male	4008190170684	50 pc(s).	IEC: 320 V / 17 A UL: 300 V / 10 A	Box
3.50/08/180		header, open side, Solder connection, 3.50 mm, No. of poles: 8, 180°, Solder pin length (l): 3.2 mm, tinned, Orange, Box				
3.2SN OR BX						

**OMNIMATE Signal - series BL/SL 3.50
BL 3.50/08/90F SN OR BX**

Weidmüller Interface GmbH & Co. KG
Klingenbergstraße 16
D-32758 Detmold
Germany
Fon: +49 5231 14-0
Fax: +49 5231 14-292083
www.weidmuller.com

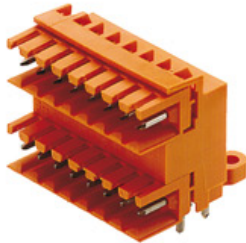
Mating connector (conditionally pluggable)
SLD 3.50/90

Two-tier pin header for wave soldering in 3.50 mm pitch. The connector is available in open, closed and flange versions. The male connectors provide space for labelling and can be coded. Packed in a cardboard box.

General ordering data

Type	Order No.	Version	GTIN (EAN)	Qty.	Product data	Packaging
SLD	1633410000	PCB plug-in connector, male	4008190257866	20 pc(s).	IEC: 200 V / 10.5 A UL: 300 V / 8 A	Box
3.50/16/90		header, open side, Solder connection, 3.50 mm, No. of poles: 16, 90°, Solder pin length (l): 3.2 mm, tinned, Orange, Box				
3.2SN OR BX						

SL-SMT 3.5/180G Tape

High-temperature-resistant male header, 3.50 mm pitch.

- **Plugging direction parallel (90°), straight 180° or angled (135°) to PCB**
- **Housing variants: closed side (G), screw flange (F), solder flange (LF) or snap-on solder flange (RF)**
- **Optimised for the SMT process**
- **Pin length 3.2 mm universal for all soldering methods**
- **Pin length 1.5 mm optimised for reflow soldering methods**
- **Packed either in a box (BX) or tape-on-reel (RL)**
- **Male header can be coded**

General ordering data

Type	Order No.	Version	GTIN (EAN)	Qty.	Product data	Packaging
SL-SMT	1753044001	PCB plug-in connector, male	4032248135646	265 pc(s).	IEC: 320 V / 15 A UL: 300 V / 10 A	Tape
3.50/08/180G		header, closed side, Reflow solder connection, 3.50 mm, No. of poles: 8, 180°, Solder pin length (l): 1.5 mm, tinned, Black, Tape (Ø 330 mm)				(Ø 330 mm)
1.5SN BK RL						

OMNIMATE Signal - series BL/SL 3.50 BL 3.50/08/90F SN OR BX

Weidmüller Interface GmbH & Co. KG
Klingenbergstraße 16
D-32758 Detmold
Germany
Fon: +49 5231 14-0
Fax: +49 5231 14-292083
www.weidmueller.com

Mating connector (conditionally pluggable)

SL 3.50/90

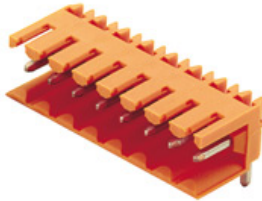

Pin headers for wave soldering in 3.50 mm pitch

- Plugging direction is parallel (90°), straight 180° or angled (135°) to the PCB
- Housing variant: screw flange (F)
- Packed in a cardboard box (BX)
- Pin header can be coded

General ordering data

Type	Order No.	Version	GTIN (EAN)	Qty.	Product data	Packaging
SL	1597270000	PCB plug-in connector, male	4008190042431	50 pc(s).	IEC: 320 V / 17 A UL: 300 V / 10 A	Box
3.50/08/90		header, open side, Solder connection, 3.50 mm, No. of poles: 8, 90°, Solder pin length (l): 3.2 mm, tinned, Orange, Box				
3.2SN OR BX						

SL-SMT 3.5/180G Box



High-temperature-resistant male header, 3.50 mm pitch.

- **Plugging direction parallel (90°), straight 180° or angled (135°) to PCB**
- **Housing variants: closed side (G), screw flange (F), solder flange (LF) or snap-on solder flange (RF)**
- **Optimised for the SMT process**
- **Pin length 3.2 mm universal for all soldering methods**
- **Pin length 1.5 mm optimised for reflow soldering methods**
- **Packed either in a box (BX) or tape-on-reel (RL)**
- **Male header can be coded**

General ordering data

Type	Order No.	Version	GTIN (EAN)	Qty.	Product data	Packaging
SL-SMT	1753042001	PCB plug-in connector, male	4032248130948	50 pc(s).	IEC: 320 V / 15 A UL: 300 V / 10 A	Box
3.50/08/180G		header, closed side, Reflow solder connection, 3.50 mm, No. of poles: 8, 180°, Solder pin length (l): 1.5 mm, tinned, Black, Box				
1.5SN BK BX						
SL-SMT	1842380000	PCB plug-in connector, male	4032248353736	50 pc(s).	IEC: 320 V / 15 A UL: 300 V / 10 A	Box
3.50/08/180G		header, closed side, Reflow solder connection, 3.50 mm, No. of poles: 8, 180°				
3.2SN BK BX						

**OMNIMATE Signal - series BL/SL 3.50
BL 3.50/08/90F SN OR BX**

Weidmüller Interface GmbH & Co. KG
Klingenbergstraße 16
D-32758 Detmold
Germany
Fon: +49 5231 14-0
Fax: +49 5231 14-292083
www.weidmueller.com

Mating connector (conditionally pluggable)

Solder pin length (l): 3.2
mm, tinned, Black, Box

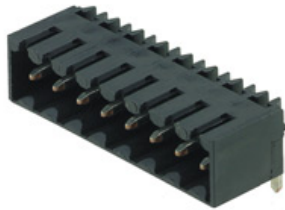
SL-SMT 3.5/90G Tape

High-temperature-resistant male header, 3.50 mm pitch.

- **Plugging direction parallel (90°), straight 180° or angled (135°) to PCB**
- **Housing variants: closed side (G), screw flange (F), solder flange (LF) or snap-on solder flange (RF)**
- **Optimised for the SMT process**
- **Pin length 3.2 mm universal for all soldering methods**
- **Pin length 1.5 mm optimised for reflow soldering methods**
- **Packed either in a box (BX) or tape-on-reel (RL)**
- **Male header can be coded**

General ordering data

Type	Order No.	Version	GTIN (EAN)	Qty.	Product data	Packaging
SL-SMT	1761604001	PCB plug-in connector, male	4032248136049	385 pc(s).	IEC: 320 V / 15 A	Tape
3.50/08/90G		header, closed side, Reflow			UL: 300 V / 10 A	(Ø
1.5SN BK RL		solder connection, 3.50				330
		mm, No. of poles: 8, 90°,				mm)
		Solder pin length (l): 1.5				
		mm, tinned, Black, Tape (Ø				
		330 mm)				

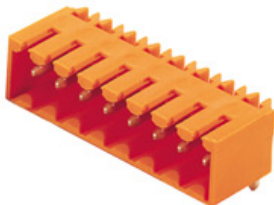
SL 3.50/90G

Pin headers for wave soldering in 3.50 mm pitch

- **Plugging direction is parallel (90°), straight 180° or angled (135°) to the PCB**
- **Housing variant: screw flange (F)**
- **Packed in a cardboard box (BX)**
- **Pin header can be coded**

General ordering data

Type	Order No.	Version	GTIN (EAN)	Qty.	Product data	Packaging
SL	1605130000	PCB plug-in connector, male	4008190172022	50 pc(s).	IEC: 320 V / 17 A	Box
3.50/08/90G		header, closed side, Solder			UL: 300 V / 10 A	
3.2SN OR BX		connection, 3.50 mm, No.				
		of poles: 8, 90°, Solder pin				

Data sheet

**OMNIMATE Signal - series BL/SL 3.50
BL 3.50/08/90F SN OR BX**

Weidmüller Interface GmbH & Co. KG
Klingenbergstraße 16
D-32758 Detmold
Germany
Fon: +49 5231 14-0
Fax: +49 5231 14-292083
www.weidmueller.com

Mating connector (conditionally pluggable)

length (l): 3.2 mm, tinned,
Orange, Box

SL 3.50/180G

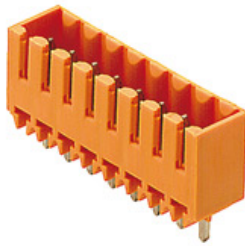

Pin headers for wave soldering in 3.50 mm pitch

- Plugging direction is parallel (90°), straight 180° or angled (135°) to the PCB
- Housing variant: screw flange (F)
- Packed in a cardboard box (BX)
- Pin header can be coded

General ordering data

Type	Order No.	Version	GTIN (EAN)	Qty.	Product data	Packaging
SL	1604530000	PCB plug-in connector, male	4008190090975	50 pc(s).	IEC: 320 V / 17 A	Box
3.50/08/180G		header, closed side, Solder connection, 3.50 mm, No. of poles: 8, 180°, Solder pin length (l): 3.2 mm, tinned, Orange, Box			UL: 300 V / 10 A	

OMNIMATE Signal - series BL/SL 3.50 BL 3.50/08/90F SN OR BX

Weidmüller Interface GmbH & Co. KG
Klingenbergstraße 16
D-32758 Detmold
Germany
Fon: +49 5231 14-0
Fax: +49 5231 14-292083
www.weidmueller.com

Mating connector (fully pluggable)

SL-SMT 3.5/90LF Tape



High-temperature-resistant male header, 3.50 mm pitch.

- **Plugging direction parallel (90°), straight 180° or angled (135°) to PCB**
- **Housing variants: closed side (G), screw flange (F), solder flange (LF) or snap-on solder flange (RF)**
- **Optimised for the SMT process**
- **Pin length 3.2 mm universal for all soldering methods**
- **Pin length 1.5 mm optimised for reflow soldering methods**
- **Packed either in a box (BX) or tape-on-reel (RL)**
- **Male header can be coded**

General ordering data

Type	Order No.	Version	GTIN (EAN)	Qty.	Product data	Packaging
SL-SMT 3.50/08/90LF 1.5SN BK RL	1805370000	PCB plug-in connector, male header, Solder flange, Reflow solder connection, 3.50 mm, No. of poles: 8, 90°, Solder pin length (l): 1.5 mm, tinned, Black, Tape (Ø 330 mm)	4032248269723	385 pc(s).	IEC: 320 V / 15 A UL: 300 V / 10 A	Tape (Ø 330 mm)

SLD 3.50V/90F



Double-level, staggered pin header for wave soldering at 3.50 mm pitch. They are available in closed and flanged versions. The male connectors provide space for labelling and can be coded.

General ordering data

Type	Order No.	Version	GTIN (EAN)	Qty.	Product data	Packaging
SLD 3.50 V/16/90F 3.2 SN OR BX	1642400000	PCB plug-in connector, male header, Flange, Solder connection, 3.50 mm, No. of poles: 16, 90°, Solder pin length (l): 3.2 mm, tinned, Orange, Box	4008190280925	20 pc(s).	IEC: 200 V / 10.5 A UL: 300 V / 8 A	Box

OMNIMATE Signal - series BL/SL 3.50 BL 3.50/08/90F SN OR BX

Weidmüller Interface GmbH & Co. KG
Klingenbergstraße 16
D-32758 Detmold
Germany
Fon: +49 5231 14-0
Fax: +49 5231 14-292083
www.weidmuller.com

Mating connector (fully pluggable)

SL 3.50/90F

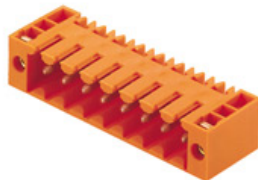

Pin headers for wave soldering in 3.50 mm pitch

- Plugging direction is parallel (90°), straight 180° or angled (135°) to the PCB
- Housing variant: screw flange (F)
- Packed in a cardboard box (BX)
- Pin header can be coded

General ordering data

Type	Order No.	Version	GTIN (EAN)	Qty.	Product data	Packaging
SL 3.50/08/90F 3.2SN OR BX	1607100000	PCB plug-in connector, male header, Flange, Solder connection, 3.50 mm, No. of poles: 8, 90°, Solder pin length (l): 3.2 mm, tinned, Orange, Box	4008190157661	50 pc(s).	IEC: 320 V / 17 A UL: 300 V / 10 A	Box

SL-SMT 3.5/180LF Box



High-temperature-resistant male header, 3.50 mm pitch.

- **Plugging direction parallel (90°), straight 180° or angled (135°) to PCB**
- **Housing variants: closed side (G), screw flange (F), solder flange (LF) or snap-on solder flange (RF)**
- **Optimised for the SMT process**
- **Pin length 3.2 mm universal for all soldering methods**
- **Pin length 1.5 mm optimised for reflow soldering methods**
- **Packed either in a box (BX) or tape-on-reel (RL)**
- **Male header can be coded**

General ordering data

Type	Order No.	Version	GTIN (EAN)	Qty.	Product data	Packaging
SL-SMT 3.50/08/180LF 1.5SN BK BX	1804760000	PCB plug-in connector, male header, Solder flange, Reflow solder connection, 3.50 mm, No. of poles: 8, 180°, Solder pin length (l): 1.5 mm, tinned, Black, Box	4032248268542	50 pc(s).	IEC: 320 V / 15 A UL: 300 V / 10 A	Box
SL-SMT 3.50/08/180LF 3.2SN BK BX	1842600000	PCB plug-in connector, male header, Solder flange, Reflow solder connection, 3.50 mm, No. of poles: 8,	4032248353965	50 pc(s).	IEC: 320 V / 15 A UL: 300 V / 10 A	Box

OMNIMATE Signal - series BL/SL 3.50 BL 3.50/08/90F SN OR BX

Weidmüller Interface GmbH & Co. KG
 Klängenbergstraße 16
 D-32758 Detmold
 Germany
 Fon: +49 5231 14-0
 Fax: +49 5231 14-292083
 www.weidmueller.com

Mating connector (fully pluggable)

180°, Solder pin length (l):
 3.2 mm, tinned, Black, Box

SLD 3.50V/180F

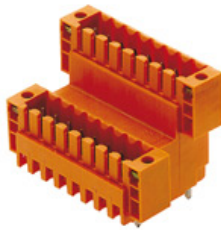

Double-level, staggered pin header for wave soldering at 3.50 mm pitch. They are available in closed and flanged versions. The male connectors provide space for labelling and can be coded.

General ordering data

Type	Order No.	Version	GTIN (EAN)	Qty.	Product data	Packaging
SLD 3.50 V/16/180F 3.2 SN OR BX	1641270000	PCB plug-in connector, male header, Flange, Solder connection, 3.50 mm, No. of poles: 16, 180°, Solder pin length (l): 3.2 mm, tinned, Orange, Box	4008190279677	20 pc(s).	IEC: 200 V / 10.5 A UL: 300 V / 8 A	Box

SL-SMT 3.5/90F Box



High-temperature-resistant male header, 3.50 mm pitch.

- **Plugging direction parallel (90°), straight 180° or angled (135°) to PCB**
- **Housing variants: closed side (G), screw flange (F), solder flange (LF) or snap-on solder flange (RF)**
- **Optimised for the SMT process**
- **Pin length 3.2 mm universal for all soldering methods**
- **Pin length 1.5 mm optimised for reflow soldering methods**
- **Packed either in a box (BX) or tape-on-reel (RL)**
- **Male header can be coded**

General ordering data

Type	Order No.	Version	GTIN (EAN)	Qty.	Product data	Packaging
SL-SMT 3.50/08/90F 3.2SN BK BX	1842140000	PCB plug-in connector, male header, Flange, Reflow solder connection, 3.50 mm, No. of poles: 8, 90°, Solder pin length (l): 3.2 mm, tinned, Black, Box	4032248353491	50 pc(s).	IEC: 320 V / 15 A UL: 300 V / 10 A	Box

OMNIMATE Signal - series BL/SL 3.50 BL 3.50/08/90F SN OR BX

Weidmüller Interface GmbH & Co. KG
 Klingenbergstraße 16
 D-32758 Detmold
 Germany
 Fon: +49 5231 14-0
 Fax: +49 5231 14-292083
 www.weidmueller.com

Mating connector (fully pluggable)

SL-SMT 3.5/180LF Tape



High-temperature-resistant male header, 3.50 mm pitch.

- **Plugging direction parallel (90°), straight 180° or angled (135°) to PCB**
- **Housing variants: closed side (G), screw flange (F), solder flange (LF) or snap-on solder flange (RF)**
- **Optimised for the SMT process**
- **Pin length 3.2 mm universal for all soldering methods**
- **Pin length 1.5 mm optimised for reflow soldering methods**
- **Packed either in a box (BX) or tape-on-reel (RL)**
- **Male header can be coded**

General ordering data

Type	Order No.	Version	GTIN (EAN)	Qty.	Product data	Packaging
SL-SMT	1805290000	PCB plug-in connector,	4032248269556	265 pc(s).	IEC: 320 V / 15 A	Tape
3.50/08/180LF		male header, Solder flange,			UL: 300 V / 10 A	(Ø
1.5SN BK RL		Reflow solder connection,				330
		3.50 mm, No. of poles: 8,				mm)
		180°, Solder pin length (l):				
		1.5 mm, tinned, Black, Tape				
		(Ø 330 mm)				

SL-SMT 3.5/90LF Box



High-temperature-resistant male header, 3.50 mm pitch.

- **Plugging direction parallel (90°), straight 180° or angled (135°) to PCB**
- **Housing variants: closed side (G), screw flange (F), solder flange (LF) or snap-on solder flange (RF)**
- **Optimised for the SMT process**
- **Pin length 3.2 mm universal for all soldering methods**
- **Pin length 1.5 mm optimised for reflow soldering methods**
- **Packed either in a box (BX) or tape-on-reel (RL)**
- **Male header can be coded**

General ordering data

Type	Order No.	Version	GTIN (EAN)	Qty.	Product data	Packaging
SL-SMT	1805000000	PCB plug-in connector,	4032248268900	50 pc(s).	IEC: 320 V / 15 A	Box
3.50/08/90LF		male header, Solder flange,			UL: 300 V / 10 A	
1.5SN BK BX		Reflow solder connection,				

**OMNIMATE Signal - series BL/SL 3.50
BL 3.50/08/90F SN OR BX**

Weidmüller Interface GmbH & Co. KG
Klingenbergstraße 16
D-32758 Detmold
Germany
Fon: +49 5231 14-0
Fax: +49 5231 14-292083
www.weidmueller.com

Mating connector (fully pluggable)

3.50 mm, No. of poles: 8,
90°, Solder pin length (l):
1.5 mm, tinned, Black, Box

SL-SMT	1841920000	PCB plug-in connector,	4032248353279 50 pc(s).	IEC: 320 V / 15 A	Box
3.50/08/90LF		male header, Solder flange,		UL: 300 V / 10 A	
3.2SN BK BX		Reflow solder connection, 3.50 mm, No. of poles: 8, 90°, Solder pin length (l): 3.2 mm, tinned, Black, Box			

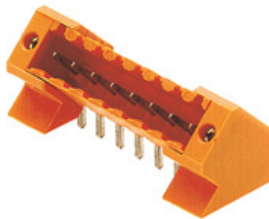
SL 3.50/135F

Pin headers for wave soldering in 3.50 mm pitch

- Plugging direction is parallel (90°), straight 180° or angled (135°) to the PCB
- Housing variant: screw flange (F)
- Packed in a cardboard box (BX)
- Pin header can be coded

General ordering data

Type	Order No.	Version	GTIN (EAN)	Qty.	Product data	Packaging
SL	1643390000	PCB plug-in connector,	4008190282158 50 pc(s).		IEC: 320 V / 15 A	Box
3.50/08/135F		male header, Flange, Solder			UL: 300 V / 10 A	
3.2SN OR BX		connection, 3.50 mm, No. of poles: 8, 135°, Solder pin length (l): 3.2 mm, tinned, Orange, Box				

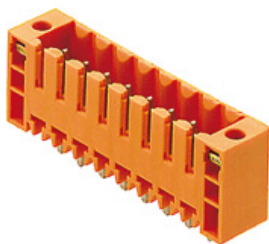
SL 3.50/180F

Pin headers for wave soldering in 3.50 mm pitch

- Plugging direction is parallel (90°), straight 180° or angled (135°) to the PCB
- Housing variant: screw flange (F)
- Packed in a cardboard box (BX)
- Pin header can be coded

General ordering data

Type	Order No.	Version	GTIN (EAN)	Qty.	Product data	Packaging
SL	1607560000	PCB plug-in connector,	4008190025151 50 pc(s).		IEC: 320 V / 17 A	Box
3.50/08/180F		male header, Flange, Solder			UL: 300 V / 10 A	
3.2SN OR BX		connection, 3.50 mm, No. of poles: 8, 180°, Solder pin length (l): 3.2 mm, tinned, Orange, Box				

OMNIMATE Signal - series BL/SL 3.50 BL 3.50/08/90F SN OR BX

Weidmüller Interface GmbH & Co. KG
 Klingenbergstraße 16
 D-32758 Detmold
 Germany
 Fon: +49 5231 14-0
 Fax: +49 5231 14-292083
 www.weidmueller.com

Mating connector (fully pluggable)

SL-SMT 3.5/180F Box



High-temperature-resistant male header, 3.50 mm pitch.

- **Plugging direction parallel (90°), straight 180° or angled (135°) to PCB**
- **Housing variants: closed side (G), screw flange (F), solder flange (LF) or snap-on solder flange (RF)**
- **Optimised for the SMT process**
- **Pin length 3.2 mm universal for all soldering methods**
- **Pin length 1.5 mm optimised for reflow soldering methods**
- **Packed either in a box (BX) or tape-on-reel (RL)**
- **Male header can be coded**

General ordering data

Type	Order No.	Version	GTIN (EAN)	Qty.	Product data	Packaging
SL-SMT 3.50/08/180F 1.5SN BK BX	1761022001	PCB plug-in connector, male header, Flange, Reflow solder connection, 3.50 mm, No. of poles: 8, 180°, Solder pin length (l): 1.5 mm, tinned, Black, Box	4032248131594	50 pc(s).	IEC: 320 V / 15 A UL: 300 V / 10 A	Box
SL-SMT 3.50/08/180F 3.2SN BK BX	1842830000	PCB plug-in connector, male header, Flange, Reflow solder connection, 3.50 mm, No. of poles: 8, 180°, Solder pin length (l): 3.2 mm, tinned, Black, Box	4032248354191	50 pc(s).	IEC: 320 V / 15 A UL: 300 V / 10 A	Box
SL-SMT 3.50/08/180F 1.5SN BK RL	1761024001	PCB plug-in connector, male header, Flange, Reflow solder connection, 3.50 mm, No. of poles: 8, 180°, Solder pin length (l): 1.5 mm, tinned, Black, Tape (Ø 330 mm)	4032248135851	265 pc(s).	IEC: 320 V / 15 A UL: 300 V / 10 A	Tape (Ø 330 mm)

**OMNIMATE Signal - series BL/SL 3.50
BL 3.50/08/90F SN OR BX**

Weidmüller Interface GmbH & Co. KG
Klingenbergstraße 16
D-32758 Detmold
Germany
Fon: +49 5231 14-0
Fax: +49 5231 14-292083
www.weidmueller.com

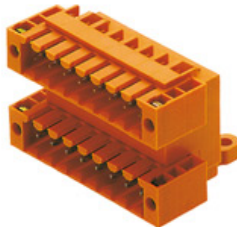
Mating connector (fully pluggable)
SLD 3.50/90F

Two-tier pin header for wave soldering in 3.50 mm pitch. The connector is available in open, closed and flange versions. The male connectors provide space for labelling and can be coded. Packed in a cardboard box.

General ordering data

Type	Order No.	Version	GTIN (EAN)	Qty.	Product data	Packaging
SLD 3.50/16/90F 3.2SN OR BX	1633870000	PCB plug-in connector, male header, Flange, Solder connection, 3.50 mm, No. of poles: 16, 90°, Solder pin length (l): 3.2 mm, tinned, Orange, Box	4008190258320	20 pc(s).	IEC: 200 V / 10.5 A UL: 300 V / 8 A	Box

Adressen weltweit

Let's connect.

- AE Vereinigte Arabische Emirate**
Weidmüller Middle East FZE
Warehouse Q3-79
SAIF-Zone
P.O. BOX 8591
Sharjah
Telefonnummer +971 65572723
Faxnummer +971 65572724
wme.info@weidmueller.com
- AO Angola**
Bitte kontaktieren Sie
Phambili Interface
Südafrika
- AR Argentinien**
CPI SA
Bauness 2660
C1431DOF Buenos Aires
Telefonnummer +54 11 4523 8008
Faxnummer +54 11 4522 0546
info@cpi.com.ar
www.cpi.com.ar
- AT Österreich**
Weidmüller GmbH
IZ NOE Süd Straße 2b, Obj M 59
2355 Wiener Neudorf
Telefonnummer +43 2236 67080
Faxnummer +43 2236 6708-899
office.at@weidmueller.com
www.weidmueller.com
- AU Australia**
Weidmüller Pty. Ltd.
PO BOX 6944
Huntingwood 2148
Huntingwood Drive 43
Huntingwood NSW 2148
Telefonnummer +61 2 9671 9999
Faxnummer +61 2 9671 9911
info@weidmuller.com.au
www.weidmuller.com.au
- AZ Aserbaidtschan**
Repräsentanz Büro
Rashad Mahmudov
Demirchi Tower, 4th floor
37, Khojali ave.
AZ 1025 Baku
Telefonnummer +994 12 488 80 36
Faxnummer +994 12 488 80 37
rashad.mahmudov@weidmueller.com
- BA Bosnien und Herzegowina**
Bitte kontaktieren Sie
unser Representative Office
Weidmüller Interface GmbH & Co. KG
Serbien
oder
BIG electric d.o.o
Mladena Stojanovića 117A
78000 Banja Luka
Telefonnummer +387 51926277
Faxnummer +387 51926277
bigelectric@blic.net
www.bigelectric.ba
- BE Belgien**
Weidmüller Benelux B. V.
Mechelsesteenweg 519 bus
6 an 7
1930 Nossegem
Telefonnummer +32 2 752 40 70
Faxnummer +32 2 751 36 06
info@weidmueller.be
www.weidmueller.be
- BG Bulgarien**
Weid-Bul EOOD
Bul. "Kliment Ohridski" 13
1756 Sofia
Telefonnummer +359 2 963 2560
Faxnummer +359 2 963 1098
sofia@weidbul.com
www.weidbul.com
- BH Bahrain**
Khayber Trading Company
P.O Box 1976
Manama
Telefonnummer +973 720747
Faxnummer +973 720331
khayber@batelco.com.bh
- BR Brasilien**
Weidmüller Conexel do Brasil
Conexões Elétricas Ltda.
Av. Presidente Juscelino, 642 - Piraporinha
Diadema, São Paulo
09950-370
Telefonnummer +55 (11) 4366-9600
Faxnummer +55 (11) 4362-1677
vendas@weidmueller.com.br
www.weidmueller.com.br
- BW Botswana**
Bitte kontaktieren Sie
Phambili Interface
Südafrika
- BY Weißrussland**
TECHNIKON Ltd.
Lomnického 5/1705
Nezavisimosti pr. 177-9
220125 Minsk
Telefonnummer +375 17 393-11-77
Faxnummer +375 17 3930080
wm@technikon.by
- CA Kanada**
W Interconnections Canada Inc.
10 Spy Court
Markham Ontario L3R 5H6
Telefonnummer +1 (905) 475-1507 Ext. 9836
Faxnummer +1 (905) 475-2798
support@weidmuller.ca
www.weidmuller.ca
- CG Kongo**
Bitte kontaktieren Sie
Phambili Interface
Südafrika
- CH Schweiz**
Weidmüller Schweiz AG
Rundbuckstraße 2
8212 Neuhausen am Rheinfall SH
Telefonnummer +41 52 674 07 07
Faxnummer +41 52 674 07 08
info@weidmueller.ch
www.weidmueller.ch
- CL Chile**
ATS - INTECH
Maria Luisa Santander 0475
Santiago
Providencia 7500859
Telefonnummer +56 2 341 1271
Faxnummer +56 2 341 1275
felipe@atsintech.com
www.atsintech.com
CPI CHILE LTDA
Av. Presidente Frei Montalva 6001, 47 complejo el cortijo
Santiago - Conchalí
Telefonnummer +562 963 8440
cpi@cpichile.cl
www.cpicchile.cl
- CN China**
Weidmüller Interface
(Shanghai) Co. Ltd.
100 Yutong Road
25 F, BM Intercontinental
Business Center
200070 Shanghai
Telefonnummer +86 21-22195008
Faxnummer +86 512-68417505
customer.hotline@weidmueller.com.cn
www.cnweidmuller.com
- CO Kolumbien**
Automatización Avanzada S. A.
Carrera 97 No., 24 c - 23
Bodega 4
110911 Bogotá-D.C.
Telefonnummer +57 (1) 547-8510
Faxnummer +57 (1) 422-3044
comercial@automatizacionavanzada.com
www.automatizacionavanzada.com
- CR Costa Rica**
ELVATRON S. A.
la Uruca 400 Norte Banco
Costa Rica
San Jose Costa Rica
Telefonnummer +506 2961-060
Faxnummer +506 5200-609
dirk.haase@elvatron.com
www.elvatron.com
- CZ Tschechische Republik**
Weidmüller s.r.o.
Lomnického 5/1705
140 00 Praha 4
Telefonnummer +420 244 001 400
Faxnummer +420 244 001 499
office@weidmueller.cz
www.weidmueller.cz
- DE Deutschland**
Weidmüller GmbH & Co. KG
Ohmstraße 9
32758 Detmold
Postfach 30 54
32720 Detmold
Telefonnummer +49 5231 1428-0
Faxnummer +49 5231 14-292083
weidmuller@weidmueller.de
www.weidmueller.de
- DK Dänemark**
Weidmüller Danmark
Vallensbækvej 18A
2605 Brøndby
Telefonnummer +45 27747800
kundeservice@weidmuller.dk
www.weidmuller.dk
- DZ Algerien**
SARL INTER ELECTRIC
1a Angles des Rues Okba Ibn Nafaa et Hassi Beida
2300 Annaba
Telefonnummer
Faxnummer
contact@inter-electric.com
- EC Ecuador**
Elsystec S. A., Electricidad
Sistemas y Tecnología
Vasco de Contreras N35-251
y Manosca
Quito - Pichincha
Telefonnummer +593 22456510
Faxnummer +593 22456755
Elsystec@uio.satnet.net
- EE Estland**
Bitte kontaktieren Sie
unser Representative Office
Weidmüller Interface GmbH & Co. KG
Lettland
oder
Soots Interface OÜ
Pärnu mnt 142
11317 Tallinn
Telefonnummer +372 609 6933
Faxnummer
info@sootsinterface.ee
www.sootsinterface.ee
- EG Ägypten**
Standard Electric (OMEGA)
1, Abdelhamid Badawy Street
Heliopolis
Cairo
Telefonnummer +202 21805600
stdelec@rite.com
- ES Spanien**
Weidmüller, S. A.
Narcís Monturiol 11-13, Pol. Ind. Sudoeste
8960 Sant Just Desvern - Barcelona
Telefonnummer +34 934 803 386
Faxnummer +34 933 718 055
weidmuller@weidmuller.es
www.weidmuller.es
- FI Finnland**
Weidmüller Suomi,
Weidmüller Aktiebolagetin
sivuliike
Koy Plaza Vivace
Äyritie 8C
FI 15100 Vantaa
Telefonnummer +358 20 7351300
Faxnummer +358 800 114 667
asiakaspalvelu@weidmuller.fi
www.weidmuller.fi
- FR Frankreich**
Weidmüller E. U. R. L.
12, Chaussée Jules César
BP 263 Osny
95523 Cergy-Pontoise Cedex
Telefonnummer +33 1 34 24 55 00
Faxnummer +33 1 34 24 55 01
mail@weidmuller.fr
- GB Großbritannien**
Weidmüller Ltd.
Klippon House
Centurion Court Office Park,
Meridian East, Meridian
Business Park
Leicester
LE19 1TP
Telefonnummer +44 116 282 3470
Faxnummer +44 116 289 3582
marketing@weidmuller.co.uk
www.weidmuller.co.uk
- GE Georgien**
Bitte kontaktieren Sie
unser Representative Office
Rashad Mahmudov
Aserbaidtschan.
- GH Ghana**
Bitte kontaktieren Sie
Weidmüller Interface GmbH & Co. KG
Südafrika
- GR Griechenland**
G.A. Solutions
Ippokratous 11 Metamorfosi
144 52 Athen
Telefonnummer +30 210 2823233
Faxnummer +30 210 2823233
info@weidmuller.gr
www.weidmuller.gr
- GT Guatemala**
Prestelectro, Prestegard
Electro, S.A.
Avenida Petapa 44-22,
Zona 12
Guatemala City
Telefonnummer +502 2442-3346
Faxnummer +502 2476-8945
ventas@prestelectro.com
- HK Hong Kong**
Weidmüller (Hong Kong)
Limited Co. Ltd.
Unit 1617, Metropolis Tower
No. 10 Metropolis Drive,
Hungghom, Kowloon
Telefonnummer +852 3154 8088
Faxnummer +852 31548099
Info-hk@weidmueller.com.hk
- HR Kroatien**
ElektroPARTNER d.o.o.
Slavonska avenija 24/6
HR-10000 Zagreb
Telefonnummer +385 (1) 6184 793
Faxnummer +385 (1) 6184 795
elektropartner@zg.t-com.hr
www.elektropartner.hr
- HU Ungarn**
Weidmüller Kereskedelmi Kft.
Budapest
Gubacsi út 6.
1097
Telefonnummer +36 1 382 7700
Faxnummer +36 1 382 7701
info@weidmueller.hu
www.weidmueller.hu
- ID Indonesien**
PT. Nego Electrindo
Ruko Mega Grosir Cempaka
Mas Blok I No. 20 – 22
Jakarta 10640
Telefonnummer +62 21 42882255
Faxnummer +62 21 42882266
sales@negoelectrindo.co.id
- IE Irland**
Bitte kontaktieren Sie
Weidmüller Ltd.
Großbritannien
- IL Israel**
A. U. Shay Ltd.
23/25, Embar Street
49222 Petach-Tikva
P.O. Box 1 00 49
49222 Petach-Tikva
Telefonnummer +972 3-923-3601
Faxnummer +972 3-923-4601
shay@uriel-shay.com
www.uriel-shay.com
ATEKA Ltd.
4, Ha Tavor lane Industrial
area Segula
49691 Petach-Tikva
P.O. Box 4710
Petach-Tikva
Telefonnummer +972 73-200-1311
Faxnummer +972 3-924 4245
marketing@ateka.co.il
www.ateka.co.il
- IN Indien**
Repräsentanz Büro
Weidmüller Electronics India
Pvt. Ltd.
12th Lane North Avenue, Opp
Joggers Park,
Kalyani Nagar, Pune
411 006
Telefonnummer +91 20-41290090
wmi.pune@weidmueller.in
www.weidmueller.com
- IS Island**
Samey Automation Center
Lyngas 13
210 Garoabaer
Telefonnummer +354 510 5200
Faxnummer +354 510 5201
Samey@samey.is
www.samey.is
- IT Italien**
Weidmüller S. r.l.
Via Albert Einstein 4
20092 Cinisello
Balsamo Milano
Telefonnummer +39 02 660681
Faxnummer +39 02 6124945
weidmuller@weidmuller.it
www.weidmuller.it
- JM Jamaika**
Bitte kontaktieren Sie
W Interconnections Inc.
USA
- JO Jordanien**
Trans Jordan for Electro
PO Box 33 06 07
Amman
Telefonnummer +962 6 533 2020
Faxnummer +962 6 533 5800
transjordan@batelco.jo



Alle Weidmüller Adressen sowie Ihren lokalen Ansprechpartner finden Sie im Internet unter: www.weidmueller.com/countries

Vertriebsgesellschaft 
 Auslandsvertretung 
 ohne Auslandsvertretung 

Let's connect.

- JP Japan**
 Nihon Weidmüller Co. Ltd.
 Sphere Tower Tennoz 2-2-8
 Higashi-Shinagawa,
 Shinagawa-ku
 Tokyo
 140-0002
 Telefonnummer +81 3 6711
 5300
 Faxnummer +81 3 6711
 5333
weidmullerjapan@weidmuller.co.jp
www.weidmuller.co.jp
- KE Kenia**
 Bitte kontaktieren Sie
 Phambili Interface
 Südafrika
- KR Korea**
 Weidmüller Korea Co. Ltd.
 9th floor, Wombang B/D
 Samseong 2-Dong, Gangnam-
 Gu
 Seoul 143-42
 Telefonnummer +82 2-516-
 0003
 Faxnummer +82 2-516-0090
info@weidmuller.co.kr
www.weidmuller.co.kr
- KW Kuwait**
 Kana Controls General Trading
 & Contracting Co. W. L. L.
 Al Rai Industrial Area, Plot
 28-30, St. 31
 13016 Safat
 B.P. 25593
 Telefonnummer +965
 4741373
 Faxnummer +965 4741537
info@kanacontrols.com
- KZ Kasachstan**
 Bitte kontaktieren Sie
 OOO Weidmüller
 Russland
- LB Libanon**
 Progress Engineering &
 Trading Enterprises
 Al Nahr Street
 Beirut 11-1111
 Telefonnummer +961 1
 444 664
 Faxnummer +961 1 561 880
progress@inco.com.lb
- LT Litauen**
 Bitte kontaktieren Sie
 unser Representative Office
 Weidmüller Interface GmbH
 & Co. KG
 Lettland
 oder
 ELEKTROS IRANGA
 Tinklu g. 29 a
 LT-5319 Panevezys
 Telefonnummer +370 (45)
 582 828
 Faxnummer
info@eliranga.lt
- LU Luxemburg**
 Bitte kontaktieren Sie
 Weidmüller Benelux B. V.
 Niederlande
- LV Lettland**
 SIA Abi4
 Daugavgrivas 31b
 Riga, LV-1007
 Telefonnummer +371 674
 70999
 Faxnummer +371 676
 24562
abi_4@tvnet.lv
 Repräsentanz Büro
 Weidmüller Interface GmbH
 & Co. KG
 Udens str. 12-118
 Riga, LV-1007
 Telefonnummer +371
 29254766
 Faxnummer +371 674
 65637
ilgonis.rudaks@weidmueller.com
www.weidmueller.com
- MA Marokko**
 Sofimed
 137, Bd Moulay Ismail Roches
 Noires
 20290 Casablanca
 Telefonnummer
 Faxnummer
contact@sofimedmaroc.com
- MD Moldawien**
 BERHORD A & D srl
 79/1, str. Milescu Spartaru
 MD-2075 Chisinau
 Moldova
 Telefonnummer +373 (22)
 815002
 Faxnummer +373 (22)
 815007
atuleanu@berhord.com
www.ad.berhord.com
- ME Montenegro**
 Bitte kontaktieren Sie
 unser Representative Office
 Weidmüller Interface GmbH
 & Co. KG
 Serbien.
- MG Madagaskar**
 Bitte kontaktieren Sie
 Phambili Interface
 Südafrika
- MK Mazedonien**
 Bitte kontaktieren Sie
 unser Representative Office
 Weidmüller Interface GmbH
 & Co. KG
 Serbien
 oder
 ELEKTRO - SMK doool
 UL. III Makedonska brigada
 b.b.
 1000 Skopje
 Telefonnummer +389
 22460295
 Faxnummer
Elektro-smk@tekelelab.net.mk
- MT Malta**
 E. S. S., Electrical Supplies &
 Services Ltd.
 San Gwakkin Road
 Mriehel
 Telefonnummer +356
 21255777
 Faxnummer +356 2 1255999
robert.agius@ess.com.mt
- MU Mauritius**
 Mubelo Electrical Ltd.
 Office 26, Gateway building,
 St. Jean Road
 Quatre Bornes
 Mauritius
 Telefonnummer +230
 4670989
 Faxnummer +230 4654051
richard.mubelo@orange.mu
- MW Malawi**
 Bitte kontaktieren Sie
 Phambili Interface
 Südafrika
- MX Mexiko**
 W Interconnections S. A.
 DE C. V.
 Blvd. Hermanos Serdán 698,
 Col. San Rafael Oriente
 72029 Puebla
 Telefonnummer +52 (222)
 268 6227
 Faxnummer +52 (222) 286
 6242
clientes@weidmuller.com.mx
- MY Malaysia**
 Connect Plus Technology
 Sdn Bhd
 No. 43, Jalan PJS 11/22,
 Bandar Sunway
 46150 Petaling Jaya
 Selangor Darul Ehsan
 Telefonnummer +60 3 5633
 7363
 Faxnummer +60 3 5633
 6562
paul@cptech.com.my
www.cptech.com.my
- MZ Mosambik**
 Bitte kontaktieren Sie
 Phambili Interface
 Südafrika
- NA Namibia**
 Bitte kontaktieren Sie
 Phambili Interface
 Südafrika
- NG Nigeria**
 Bitte kontaktieren Sie
 Weidmüller Interface GmbH
 & Co. KG
 Südafrika
- NL Niederlande**
 Weidmüller Benelux B. V.
 Franciscusweg 221
 1216 SE Hilversum
 Postfach 1505
 1200 BM Hilversum
 Telefonnummer +31 35 626
 12 61
 Faxnummer +31 35 623
 20 44
info@weidmuller.nl
www.weidmuller.nl
- NO Norwegen**
 Sivilingeniør J.F. Knudtzen AS
 Billingstadsletta 97
 1396 Billingstad
 PO Box 160
 1378 Nesbru
 Telefonnummer +47 66 98
 33 50
 Faxnummer +47 66 98 09 55
firmapost@fknudtzen.no
www.fknudtzen.no
- NZ Neuseeland**
 Cuthbert S. Steward Ltd.
 27 Te Puni Street
 Petone
 PO Box 38496
 Wellington Mail Centre 5054
 Telefonnummer (04) 568
 6156
 Faxnummer (09) 489 1752
cslak@cuthbertstewart.co.nz
 Cuthbert S. Steward Ltd
 4 Fred Thomas Drive
 Aon Building, Ground Floor,
 South Entry
 Takapuna
 PO Box 100 338
 North Shore City 745
 Telefonnummer (09) 489
 1751
 Faxnummer (04) 568 6056
cslak@cuthbertstewart.co.nz
- OM Oman**
 DAN INTERNATIONAL LLC.
 Ghala St. 111
 BP 2901
 Seeb
 Telefonnummer +968
 5036 77
 Faxnummer +968 5037 55
yeidu@danintl.com
- PE Peru**
 IMPEXINCA S.A.C.
 Calle Ortiz de Zavallos No.
 105, Urb. San Antonio
 18
 Lima, Miraflores
 Telefonnummer +51 1 447
 5608
info@impexinca.pe
www.impexinca.pe
 J & W CIA. S. A.
 Calle 6 Mz. D Lte. 23, Urb.
 Ind. Grimanesa
 01
 Callao
 Telefonnummer +51 1 572
 2539
 Faxnummer +51 1 572 0152
contacto@jwcia.com
www.jwcia.com
- PH Philippinen**
 Enclosure Systems Specialists
 Inc.
 2276 Don Chino Roces
 Avenue Extension
 Room 103/105 Narra Building
 1231 Makati City
 Telefonnummer +63 2 813
 8580
 Faxnummer +63 2 813 8596
sales_encsys@pltdsl.net
www.enclosuresystemspsh.com
- PK Pakistan**
 Automation Controls (Pak)
 Apartment No. 33 C III,
 Chenab Block, Allama Iqbal
 Town
 Lahore
 Telefonnummer +92 42
 37809948
 Faxnummer +92 42
 37809950
nadeem@acpak.com.pk
www.acpak.com.pk
- PL Polen**
 Weidmüller Sp. z o. o.
 ul. Ogrodowa 58
 00-876 Warszawa
 Telefonnummer +48 22 510
 09 40
 Faxnummer +48 22 510
 09 41
biuro@weidmuller.com.pl
www.weidmuller.pl
- PR Puerto Rico**
 Bitte kontaktieren Sie
 W Interconnections Inc.
 USA
- PT Portugal**
 Weidmüller Sistemas de
 Interface S. A.
 Estrada Outeiro Polima, R.
 Augusto Dias da Silva, Lote
 B - Esct. 2
 São Domingos de Rana
 2785-515 Abóboda
 Telefonnummer +351 214
 459 191
 Faxnummer +351 214
 455 871
weidmuller@weidmuller.pt
www.weidmuller.pt
- PY Paraguay**
 Bitte kontaktieren Sie
 CPI SA
 Argentinien
- QA Katar**
 Doha Motors
 PO Box 145
 Telefonnummer +974
 4651441
 Faxnummer +974 4654579
dmtctech@qatar.net.qa
<http://www.dohamotorsgroup.com/td.html>
- RO Rumänien**
 Repräsentanz Büro
 Weidmüller Interface GmbH
 & Co. KG
 Ionescu Crum Street, No.
 1, 1st Tower, 1st Floor,
 Office 4
 500446 Brasov - Brasov
 Business Park
 Telefonnummer +40 (268)
 446 222
 Faxnummer +40 (262)
 205 410
claudiu.totea@weidmueller.com
www.weidmueller.com
- RS Serbien**
 Repräsentanz Büro
 Weidmüller Interface GmbH
 & Co. KG
 Ustanicka 189, III sprat
 lokal 7a
 11050 Beograd
 Telefonnummer +381
 112885274
 Faxnummer +381
 112885274
zoran.rabrenovic@weidmueller.com
 TeLa Elektrik d.o.o.
 Ul. Dr Drage Ljočić 6
 Beograd
 Telefonnummer +381 11
 2772 415
 Faxnummer +381 11 2772
 850
office@tela.rs
www.tela.rs
- RU Russland**
 OOO Weidmüller
 Warshavskoye highway, 25
 A. bld. 6
 Moskau
 117105
 Telefonnummer +7 (495)
 771-69-40
 Faxnummer +7 (495) 771-
 69-41
Info@weidmueller.ru
www.weidmueller.ru
- SA Saudi-Arabien**
 Al Abdulkarim Holding Co.
 P.O. Box 4
 Dammam 31411
 Telefonnummer +966 3
 8337110
 Faxnummer +966 3
 8829547
 E-Mail salehsk@akh.com.sa
www.weidmueller.ae
 Saudi Electric Supply
 Company (SESCO)
 P.O. Box 32 98
 Al Khobar 31952
 Telefonnummer +966 3
 8829546 Ext. 3030
 Faxnummer
www.sesco-gex.com
www.sesco-gex.com
- SE Schweden**
 Weidmüller AB
 Axel Danielssons väg 271
 BOX 31025
 SE-200 49 Malmö
 Telefonnummer +46 77-143
 00 44
 Faxnummer +46 40-37 48 60
info@weidmuller.se
www.weidmuller.se
- SG Singapur**
 Weidmüller Pte. Ltd.
 70 Bendemeer Road
 # 04-03 Luzerne Building
 Singapore 339940
 Telefonnummer +65 6841
 5311
 Faxnummer +65 6841 5377
info@weidmuller.com.sg
www.weidmuller.com.sg
- SI Slowenien**
 Elektrospoji d. o. o.
 Stegne 27
 SI- 1000 Ljubljana
 Osrednjeslovenska
 Telefonnummer +386 1 511
 3810
 Faxnummer +386 1 511
 1604
info@elektrospoji.si
www.elektrospoji.si
- SK Slowakei**
 ELEKTRIS s.r.o.
 Elektrárenská 1
 831 04 Bratislava
 Telefonnummer +421 2/4920
 0113
 Faxnummer +421 2/4920
 0119
bratislava@elektris.sk
- SV El Salvador**
 Prestegard Electro
 11 Avenida Norte No. 240
 Edificio Salazar No. 2
 San Salvador
 Telefonnummer +503 2271
 1690
 Faxnummer +503 2221
 3851
prestegard@navegante.com.sv
- SY Syrien**
 Bitte kontaktieren Sie
 Weidmüller Middle East FZE
 Vereinigte Arabische Emirate
- SZ Swasiland**
 Bitte kontaktieren Sie
 Phambili Interface
 Südafrika

Adressen weltweit

Let's connect.

TH Thailand
Pisanu Engineering Co. Ltd.
Kwang Dingaeng, Khet
Dingaeng
800/2 Soi Trakulsuk, Asoke-
dindaeng Road
Dindaeng, Bangkok
10400
Telefonnummer +66 2 248
2896
Faxnummer +662 105 6301
ecsales@pisanu.co.th
www.pisanu.co.th

Repräsentanz Büro
Weidmüller Pte. Ltd.
37/F, Sathorn Square Building
98 North Sathorn Road
Bangkok, Silom Bangrak
10500
Telefonnummer +66 2 105
6300
Faxnummer +66 2 642 9220
info@weidmuller.com.sg

TN Tunesien
Bitte kontaktieren Sie
Weidmüller E. U. R. L.
Frankreich

TR Türkei
Weidmüller Elektronik Ticaret
Ltd. Sirketi
Kavacik Mah. Orhan Veli Kanik
Caddesi 9/1
34810 Beykoz / Istanbul
Telefonnummer +90 (216) 537
10 70
Faxnummer +90 (216) 537
10 77
info@weidmuller.com.tr
www.weidmuller.com.tr

TW Taiwan
Weidmuller (Hong Kong)
Limited
No. 3, Lane 89, ChungYang
N. Rd
24148 SanChuang City,
Taipei
Telefonnummer +886 921
949 751
roy.lin@weidmueller.com.hk

TZ Tansania
Bitte kontaktieren Sie
Phambili Interface
Südafrika

UA Ukraine
LLC WM UKRAINE
Levanevskogo str. 6
Kiev
3058
Telefonnummer +38 044
490 32 48
Faxnummer
info@wm-ua.com.ua
wm-ua.com.ua/
Repräsentanz Büro
Weidmueller Interface GmbH
& Co. KG
Z, office 303
7-D, Zdolbunivska str.
Kiev, 2081
Telefonnummer (Mobil) +38
050 440 25 24
info.ua@weidmueller.com

US USA
W Interconnections Inc.
821 Southlake Boulevard
Richmond Virginia 23236
Telefonnummer +1 (804)
794-2877
Faxnummer +1 (804) 379-
2593
info@weidmuller.com
www.weidmuller.com

UY Uruguay
REWO Uruguay S. A.
AV. Bolivia 2001 Esq
Rocafuerte
11300 Carrasco Montevideo
Telefonnummer +598 2604
8439
Faxnummer +598 2604
8439
rewo@rewo Uruguay.com.uy

UZ Usbekistan
Bitte kontaktieren Sie
OOO Weidmüller
Russland

VE Venezuela
Somerinca C. A.
Corazon de Jesus - 3ra
Transversal con calle el
Carmen- Los Dos Caminos
Caracas 1070-A
Telefonnummer +58
2122352748
Faxnummer +58
2122399341
klocmoeller@cantv.net
www.somerinca.com

VN Vietnam
AUMI Industrial Equipment &
Automation Company Limited
E1, La Thanh Hotel
218 Doi Can Street
Lieu Giai Ward, Ba Dinh
District
Hanoi City
Telefonnummer +84 4
37628601
Faxnummer +84 4
6266 1391
aumi@aumi.com.vn
www.aumi.com.vn

Repräsentanz Büro
Weidmüller Pte. Ltd.
Level 16 Saigon Tower
Building
29 Le Duan Street
District 1
Ho Chi Minh
Telefonnummer +848 3520
7717
Faxnummer +848 3520
7604
info@weidmuller.com.sg

ZA Südafrika
Phambili Interface
PO Box 193
1609 Johannesburg, Edenvale
5 Bundo Road, Sebenza
1610 Johannesburg
Telefonnummer +27 (11)
4521930
Faxnummer
info@weidmuller.co.za
www.weidmuller.co.za

Repräsentanz Büro
Weidmüller Interface GmbH
& Co. KG
210 Amarand
Avenue, Pegasus Building
181 Pretoria, waterkloof Glen
ext 2 -
Telefonnummer +27 12 003
2906
Faxnummer +27 (11)
4526455
Jacques.Vosloo@weidmueller.
com
www.weidmueller.com

ZM Sambia
Bitte kontaktieren Sie
Phambili Interface
Südafrika

ZW Simbabwe
Bitte kontaktieren Sie
Phambili Interface
Südafrika