

**OMNIMATE Signal - series BL/SL 3.50  
BL 3.50/20/90 SN BK BX**

**Weidmüller Interface GmbH & Co. KG**  
Klingenbergstraße 16  
D-32758 Detmold  
Germany  
Fon: +49 5231 14-0  
Fax: +49 5231 14-292083  
www.weidmueller.com

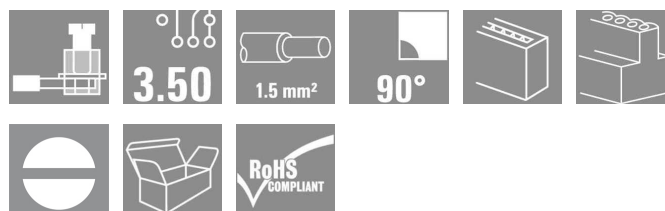

Female connectors with clamping yoke screw system for connecting conductors at 3.50 mm pitch. They provide space for labelling and can be coded.

**General ordering data**

Type	BL 3.50/20/90 SN BK BX
Order No.	<a href="#">1638960000</a>
Version	PCB plug-in connector, female plug, 3.50 mm, No. of poles: 20, 90°, Clamping yoke connection, Clamping range, rated connection, max.: 1.5 mm², Box
GTIN (EAN)	4008190276508
Qty.	20 pc(s).
Product data	IEC: 320 V / 12 A / 0.2 - 1.5 mm² UL: 300 V / 8 A / AWG 28 - AWG 14
Packaging	Box

**OMNIMATE Signal - series BL/SL 3.50  
BL 3.50/20/90 SN BK BX**

**Weidmüller Interface GmbH & Co. KG**  
 Klingenbergstraße 16  
 D-32758 Detmold  
 Germany  
 Fon: +49 5231 14-0  
 Fax: +49 5231 14-292083  
 www.weidmueller.com

**Technical data****Dimensions and weights**

Net weight	20.14 g
------------	---------

**System parameters**

Product family	OMNIMATE Signal - series BL/SL 3.50	Wire connection method	Clamping yoke connection
Conductor outlet direction	90°	Pitch in mm (P)	3.5 mm
Pitch in inches (P)	0.138 inch	No. of poles	20
Screwdriver blade	0.4 x 2.5	Screwdriver blade standard	DIN 5264
Tightening torque, min.	0.2 Nm	Tightening torque, max.	0.25 Nm
Clamping screw	M 2	Stripping length	6 mm
L1 in mm	66.5 mm	L1 in inches	2.618 inch
Touch-safe protection acc. to DIN VDE 0470	IP 20	Touch-safe protection acc. to DIN VDE 57 106	Safe from finger touch

**Material data**

Insulating material	PBT	Moisture Level (MSL)	3
Colour	Black	Colour chart (similar)	RAL 9011
UL 94 flammability rating	V-0	CTI	≥ 200
Contact material	Cu-Leg	Contact surface	tinned
Operating temperature, min.	-50 °C	Operating temperature, max.	100 °C
Temperature range, installation, min.	-30 °C	Temperature range, installation, max.	100 °C

**Connectable conductors**

Clamping range, rated connection, min.	0.08 mm <sup>2</sup>	Clamping range, rated connection, max.	1.5 mm <sup>2</sup>
Wire connection cross section AWG, min.	AWG 28	Wire connection cross section AWG, max.	AWG 14
Solid, min. H05(07) V-U	0.2 mm <sup>2</sup>	Solid, max. H05(07) V-U	1.5 mm <sup>2</sup>
Flexible, min. H05(07) V-K	0.2 mm <sup>2</sup>	Flexible, max. H05(07) V-K	1.5 mm <sup>2</sup>
w. wire end ferrule, DIN 46228 pt 1, min.	0.2 mm <sup>2</sup>	w. wire end ferrule, DIN 46228 pt 1, max.	1.5 mm <sup>2</sup>
w. plastic collar ferrule, DIN 46228 pt 4, min.	0.2 mm <sup>2</sup>	w. plastic collar ferrule, DIN 46228 pt 4, max.	1.5 mm <sup>2</sup>
Plug gauge acc. to EN 60999 a x b; Ø	2.4 mm x 1.5 mm		

**Rating data acc. to IEC 60664-1 / IEC 61984**

Rated current, min. no. of poles (Tu=20°C)	12 A	Rated current, max. no. of poles (Tu=20°C)	10 A
Rated current, number of poles (Tu=40°C), min	10 A	Rated current, number of poles (Tu=40°C), max.	8 A
Rated voltage for surge voltage class / pollution degree II/2	320 V	Rated voltage for surge voltage class / pollution degree III/2	160 V
Rated voltage for surge voltage class / pollution degree III/3	160 V	Rated impulse voltage for surge voltage class/ pollution degree II/2	2.5 kV
Rated impulse voltage for surge voltage class/ pollution degree III/2	2.5 kV	Rated impulse voltage for surge voltage class/ contamination degree III/3	2.5 kV
Short-time withstand current resistance	3 x 1s with 100 A		

**Data sheet**

**OMNIMATE Signal - series BL/SL 3.50  
BL 3.50/20/90 SN BK BX**

**Weidmüller Interface GmbH & Co. KG**  
Klingenbergstraße 16  
D-32758 Detmold  
Germany  
Fon: +49 5231 14-0  
Fax: +49 5231 14-292083  
www.weidmueller.com

**Technical data**

**CSA rating data**

Institute (CSA)		Certificate No. (CSA)	
		154685-1318353	
Rated voltage (Use group B)	300 V	Rated current (use group B)	10 A
Rated voltage (use group D)	300 V	Rated current (use group D)	10 A
Wire cross-section, AWG, min.	AWG 28	Wire cross-section, AWG, max.	AWG 14

**UL 1059 rating data**

Institute (UR)		Certificate No. (UR)	
		E60693	
Rated voltage (use group B)	300 V	Rated current (use group B)	8 A
Rated voltage (use group D)	300 V	Rated current (use group D)	8 A
Wire cross-section, AWG, min.	AWG 28	Wire cross-section, AWG, max.	AWG 14

**Classifications**

ETIM 3.0	EC001284	UNSPSC	30-21-18-10
eClass 5.1	27-26-07-04	eClass 6.2	27-26-07-04
eClass 7.1	27-44-04-02		

**Notes**

- PUR
- Additional colours on request
  - Gold-plated contact surfaces on request
  - Rated current related to rated cross-section & min. No. of poles.
  - Max. outer diameter of the conductor: 2.9 mm
  - Wire end ferrule without plastic collar to DIN 46228/1
  - Wire end ferrule with plastic collar to DIN 46228/4
  - P on drawing = pitch
  - Rated data refer only to the component itself. Clearance and creepage distances to other components are to be designed in accordance with the relevant application standards.

**Approvals**

Approvals	
ROHS	Conform

**OMNIMATE Signal - series BL/SL 3.50  
BL 3.50/20/90 SN BK BX**

**Weidmüller Interface GmbH & Co. KG**  
Klingenbergstraße 16  
D-32758 Detmold  
Germany  
Fon: +49 5231 14-0  
Fax: +49 5231 14-292083  
www.weidmueller.com

**Drawings**

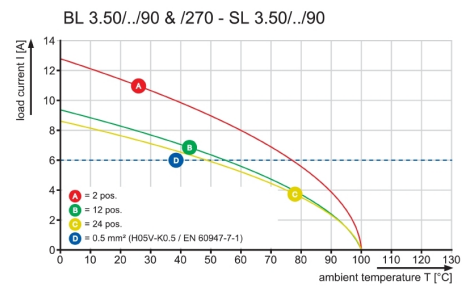
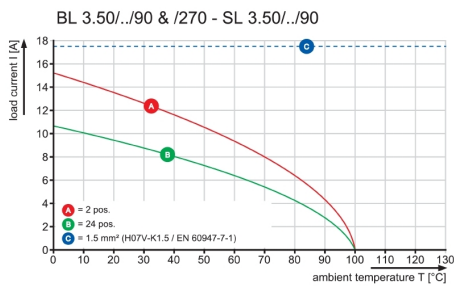
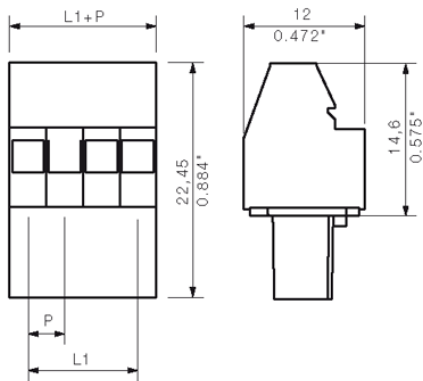

**OMNIMATE Signal - series BL/SL 3.50  
BL 3.50/20/90 SN BK BX**

**Weidmüller Interface GmbH & Co. KG**  
Klingenbergstraße 16  
D-32758 Detmold  
Germany  
Fon: +49 5231 14-0  
Fax: +49 5231 14-292083  
www.weidmueller.com

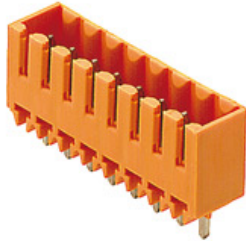
**Mating connector (fully pluggable)**
**SL 3.50/180G**

Pin headers for wave soldering in 3.50 mm pitch

- Plugging direction is parallel (90°), straight 180° or angled (135°) to the PCB
- Housing variant: screw flange (F)
- Packed in a cardboard box (BX)
- Pin header can be coded

**General ordering data**

Type	Order No.	Version	GTIN (EAN)	Qty.	Product data	Packaging
SL 3.50/20/180G 3.2SN OR BX	<a href="#">1621820000</a>	PCB plug-in connector, male header, closed side, Solder connection, 3.50 mm, No. of poles: 20, 180°, Solder pin length (l): 3.2 mm, tinned, Orange, Box	4008190181116	20 pc(s).	IEC: 320 V / 17 A UL: 300 V / 10 A	Box

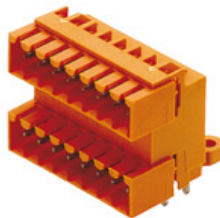
**SLD 3.50/90G**

Two-tier pin header for wave soldering in 3.50 mm pitch. The connector is available in open, closed and flange versions. The male connectors provide space for labelling and can be coded. Packed in a cardboard box.

**General ordering data**

Type	Order No.	Version	GTIN (EAN)	Qty.	Product data	Packaging
SLD 3.50/40/90G 3.2SN OR BX	<a href="#">1633760000</a>	PCB plug-in connector, male header, closed side, Solder connection, 3.50 mm, No. of poles: 40, 90°, Solder pin length (l): 3.2 mm, tinned, Orange, Box	4008190258214	10 pc(s).	IEC: 200 V / 10.5 A UL: 300 V / 8 A	Box

**OMNIMATE Signal - series BL/SL 3.50  
BL 3.50/20/90 SN BK BX**

**Weidmüller Interface GmbH & Co. KG**  
Klingenbergstraße 16  
D-32758 Detmold  
Germany  
Fon: +49 5231 14-0  
Fax: +49 5231 14-292083  
www.weidmueller.com

**Mating connector (fully pluggable)**
**SL-THR 3.5/135F**

**High-temperature-resistant male header, 3.50 mm pitch.**

- **Plugging direction parallel (90°), straight 180° or angled (135°) to PCB**
- **Housing variants: closed side (G), screw flange (F), solder flange (LF) or snap-on solder flange (RF)**
- **Optimised for the SMT process**
- **Pin length 3.2 mm universal for all soldering methods**
- **Pin length 1.5 mm optimised for reflow soldering methods**
- **Packed either in a box (BX) or tape-on-reel (RL)**
- **Male header can be coded**

**General ordering data**

Type	Order No.	Version	GTIN (EAN)	Qty.	Product data	Packaging
SL-SMT	<a href="#">1003700000</a>	PCB plug-in connector, male	4032248700325	20 pc(s).	IEC: 320 V / 15 A UL: 300 V / 10 A	Box
3.50/20/135F		header, Flange, Reflow solder connection, 3.50 mm, No. of poles: 20, 135°, Solder pin length (l): 3.2 mm, tinned, Black, Box				

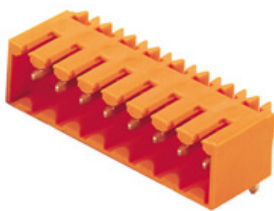
**SL 3.50/90G**

Pin headers for wave soldering in 3.50 mm pitch

- **Plugging direction is parallel (90°), straight 180° or angled (135°) to the PCB**
- **Housing variant: screw flange (F)**
- **Packed in a cardboard box (BX)**
- **Pin header can be coded**

**General ordering data**

Type	Order No.	Version	GTIN (EAN)	Qty.	Product data	Packaging
SL	<a href="#">1619410000</a>	PCB plug-in connector, male	4008190139605	20 pc(s).	IEC: 320 V / 17 A UL: 300 V / 10 A	Box
3.50/20/90G		header, closed side, Solder connection, 3.50 mm, No. of poles: 20, 90°, Solder pin length (l): 3.2 mm, tinned, Orange, Box				

**OMNIMATE Signal - series BL/SL 3.50  
BL 3.50/20/90 SN BK BX**

**Weidmüller Interface GmbH & Co. KG**  
Klingenbergstraße 16  
D-32758 Detmold  
Germany  
Fon: +49 5231 14-0  
Fax: +49 5231 14-292083  
www.weidmueller.com

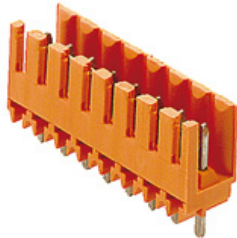
**Mating connector (fully pluggable)**
**SL 3.50/180**

Pin headers for wave soldering in 3.50 mm pitch

- Plugging direction is parallel (90°), straight 180° or angled (135°) to the PCB
- Housing variant: screw flange (F)
- Packed in a cardboard box (BX)
- Pin header can be coded

**General ordering data**

Type	Order No.	Version	GTIN (EAN)	Qty.	Product data	Packaging
SL	<a href="#">1621430000</a>	PCB plug-in connector, male header, open side, Solder connection, 3.50 mm, No. of poles: 20, 180°, Solder pin length (l): 3.2 mm, tinned, Orange, Box	4008190172510	20 pc(s).	IEC: 320 V / 17 A UL: 300 V / 10 A	Box

**SLD 3.50V/90G**

Double-level, staggered pin header for wave soldering at 3.50 mm pitch. They are available in closed and flanged versions. The male connectors provide space for labelling and can be coded.

**General ordering data**

Type	Order No.	Version	GTIN (EAN)	Qty.	Product data	Packaging
SLD	<a href="#">1642330000</a>	PCB plug-in connector, male header, closed side, Solder connection, 3.50 mm, No. of poles: 40, 90°, Solder pin length (l): 3.2 mm, tinned, Orange, Box	4008190280857	10 pc(s).	IEC: 200 V / 10.5 A UL: 300 V / 8 A	Box

## OMNIMATE Signal - series BL/SL 3.50 BL 3.50/20/90 SN BK BX

**Weidmüller Interface GmbH & Co. KG**  
Klingenbergstraße 16  
D-32758 Detmold  
Germany  
Fon: +49 5231 14-0  
Fax: +49 5231 14-292083  
www.weidmueller.com

### Mating connector (fully pluggable)

#### SLD 3.50V/180G

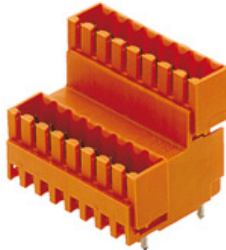

Double-level, staggered pin header for wave soldering at 3.50 mm pitch. They are available in closed and flanged versions. The male connectors provide space for labelling and can be coded.

#### General ordering data

Type	Order No.	Version	GTIN (EAN)	Qty.	Product data	Packaging
SLD	<a href="#">1641200000</a>	PCB plug-in connector, male header, closed side, Solder connection, 3.50 mm, No. of poles: 40, 180°, Solder pin length (l): 3.2 mm, tinned, Orange, Box	4008190279608	10 pc(s).	IEC: 200 V / 10.5 A UL: 300 V / 8 A	Box

#### SL-SMT 3.5/90G Box



**High-temperature-resistant male header, 3.50 mm pitch.**

- **Plugging direction parallel (90°), straight 180° or angled (135°) to PCB**
- **Housing variants: closed side (G), screw flange (F), solder flange (LF) or snap-on solder flange (RF)**
- **Optimised for the SMT process**
- **Pin length 3.2 mm universal for all soldering methods**
- **Pin length 1.5 mm optimised for reflow soldering methods**
- **Packed either in a box (BX) or tape-on-reel (RL)**
- **Male header can be coded**

#### General ordering data

Available until	Type	Order No.	Version	GTIN (EAN)	Qty.	Product data
2014-05-20	SL-SMT 3.5/90G 1.5SN BK BX	<a href="#">1761722001</a>	PCB plug-in connector, male header, closed side, Reflow solder connection, 3.50 mm, No. of poles: 20, 90°, Solder pin length (l): 1.5 mm, tinned, Black, Box	4032248132317	20 pc(s).	IEC: 320 V / 15 A UL: 300 V / 10 A



**Data sheet**

**OMNIMATE Signal - series BL/SL 3.50  
BL 3.50/20/90 SN BK BX**

**Weidmüller Interface GmbH & Co. KG**  
Klingenbergstraße 16  
D-32758 Detmold  
Germany  
Fon: +49 5231 14-0  
Fax: +49 5231 14-292083  
www.weidmueller.com

**Mating connector (fully pluggable)**

SL-SMT 3.50/20/90G 3.2SN BK BX	<a href="#">1841810000</a>	PCB plug-in connector, male header, closed side, Reflow solder connection, 3.50 mm, No. of poles: 20, 90°, Solder pin length (l): 3.2 mm, tinned, Black, Box	4032248353163 20 pc(s). IEC: 320 V / 15 A UL: 300 V / 10 A	Box
--------------------------------------	----------------------------	---	--	-----

**SL 3.50/90**

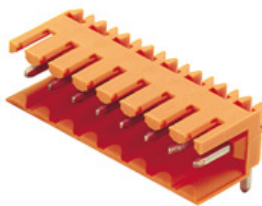

Pin headers for wave soldering in 3.50 mm pitch

- Plugging direction is parallel (90°), straight 180° or angled (135°) to the PCB
- Housing variant: screw flange (F)
- Packed in a cardboard box (BX)
- Pin header can be coded

**General ordering data**

Type	Order No.	Version	GTIN (EAN)	Qty.	Product data	Packaging
SL 3.50/20/90 3.2SN OR BX	<a href="#">1619020000</a>	PCB plug-in connector, male header, open side, Solder connection, 3.50 mm, No. of poles: 20, 90°, Solder pin length (l): 3.2 mm, tinned, Orange, Box	4008190132262	20 pc(s).	IEC: 320 V / 17 A UL: 300 V / 10 A	Box

## OMNIMATE Signal - series BL/SL 3.50 BL 3.50/20/90 SN BK BX

**Weidmüller Interface GmbH & Co. KG**  
 Klingenbergstraße 16  
 D-32758 Detmold  
 Germany  
 Fon: +49 5231 14-0  
 Fax: +49 5231 14-292083  
 www.weidmueller.com

### Mating connector (conditionally pluggable)

#### SL-SMT 3.5/90F Box



**High-temperature-resistant male header, 3.50 mm pitch.**

- **Plugging direction parallel (90°), straight 180° or angled (135°) to PCB**
- **Housing variants: closed side (G), screw flange (F), solder flange (LF) or snap-on solder flange (RF)**
- **Optimised for the SMT process**
- **Pin length 3.2 mm universal for all soldering methods**
- **Pin length 1.5 mm optimised for reflow soldering methods**
- **Packed either in a box (BX) or tape-on-reel (RL)**
- **Male header can be coded**

#### General ordering data

Type	Order No.	Version	GTIN (EAN)	Qty.	Product data	Packaging
SL-SMT	<a href="#">1842260000</a>	PCB plug-in connector, male	4032248353613	20 pc(s).	IEC: 320 V / 15 A UL: 300 V / 10 A	Box
3.50/20/90F		header, Flange, Reflow				
3.2SN BK BX		solder connection, 3.50 mm, No. of poles: 20, 90°, Solder pin length (l): 3.2 mm, tinned, Black, Box				

#### SL 3.50/90F

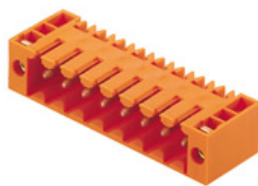

Pin headers for wave soldering in 3.50 mm pitch

- **Plugging direction is parallel (90°), straight 180° or angled (135°) to the PCB**
- **Housing variant: screw flange (F)**
- **Packed in a cardboard box (BX)**
- **Pin header can be coded**

#### General ordering data

Type	Order No.	Version	GTIN (EAN)	Qty.	Product data	Packaging
SL	<a href="#">1619800000</a>	PCB plug-in connector, male header, Flange, Solder connection, 3.50 mm, No. of poles: 20, 90°, Solder pin length (l): 3.2 mm, tinned, Orange, Box	4008190147549	20 pc(s).	IEC: 320 V / 17 A UL: 300 V / 10 A	Box
3.50/20/90F						
3.2SN OR BX						

## OMNIMATE Signal - series BL/SL 3.50 BL 3.50/20/90 SN BK BX

**Weidmüller Interface GmbH & Co. KG**  
 Klingenbergstraße 16  
 D-32758 Detmold  
 Germany  
 Fon: +49 5231 14-0  
 Fax: +49 5231 14-292083  
 www.weidmueller.com

### Mating connector (conditionally pluggable)

#### SL 3.50/135F

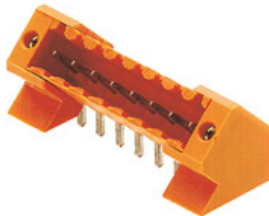

Pin headers for wave soldering in 3.50 mm pitch

- Plugging direction is parallel (90°), straight 180° or angled (135°) to the PCB
- Housing variant: screw flange (F)
- Packed in a cardboard box (BX)
- Pin header can be coded

#### General ordering data

Type	Order No.	Version	GTIN (EAN)	Qty.	Product data	Packaging
SL 3.50/20/135F 3.2SN OR BX	<a href="#">1643510000</a>	PCB plug-in connector, male header, Flange, Solder connection, 3.50 mm, No. of poles: 20, 135°, Solder pin length (l): 3.2 mm, tinned, Orange, Box	4008190282271	20 pc(s).	IEC: 320 V / 15 A UL: 300 V / 10 A	Box

#### SL-SMT 3.5/180F Box



**High-temperature-resistant male header, 3.50 mm pitch.**

- **Plugging direction parallel (90°), straight 180° or angled (135°) to PCB**
- **Housing variants: closed side (G), screw flange (F), solder flange (LF) or snap-on solder flange (RF)**
- **Optimised for the SMT process**
- **Pin length 3.2 mm universal for all soldering methods**
- **Pin length 1.5 mm optimised for reflow soldering methods**
- **Packed either in a box (BX) or tape-on-reel (RL)**
- **Male header can be coded**

#### General ordering data

Type	Order No.	Version	GTIN (EAN)	Qty.	Product data	Packaging
SL-SMT 3.50/20/180F 3.2SN BK BX	<a href="#">1842950000</a>	PCB plug-in connector, male header, Flange, Reflow solder connection, 3.50 mm, No. of poles: 20, 180°, Solder pin length (l): 3.2 mm, tinned, Black, Box	4032248354412	20 pc(s).	IEC: 320 V / 15 A UL: 300 V / 10 A	Box
2014-05-20T06:50:00SL-SMT 3.50/20/180F 1.5SN BK BX	<a href="#">1761142001</a>	PCB plug-in connector, male header, Flange, Reflow solder connection, 3.50	4032248131716	20 pc(s).	IEC: 320 V / 15 A	320

## OMNIMATE Signal - series BL/SL 3.50 BL 3.50/20/90 SN BK BX

**Weidmüller Interface GmbH & Co. KG**  
 Klingenbergstraße 16  
 D-32758 Detmold  
 Germany  
 Fon: +49 5231 14-0  
 Fax: +49 5231 14-292083  
 www.weidmueller.com

### Mating connector (conditionally pluggable)

mm, No. of poles:	UL:
20, 180°, Solder	300
pin length (l): 1.5	V /
mm, tinned, Black,	10
Box	A

### SL-SMT 3.5/180G Box



#### High-temperature-resistant male header, 3.50 mm pitch.

- **Plugging direction parallel (90°), straight 180° or angled (135°) to PCB**
- **Housing variants: closed side (G), screw flange (F), solder flange (LF) or snap-on solder flange (RF)**
- **Optimised for the SMT process**
- **Pin length 3.2 mm universal for all soldering methods**
- **Pin length 1.5 mm optimised for reflow soldering methods**
- **Packed either in a box (BX) or tape-on-reel (RL)**
- **Male header can be coded**

### General ordering data

Available until	Type	Order No.	Version	GTIN (EAN)	Qty.	Product data
2014-05-20	SL-SMT 3.5/180G 20/180G 1.5SN BK BX	<a href="#">1753162001</a>	PCB plug-in connector, male header, closed side, Reflow solder connection, 3.50 mm, No. of poles: 20, 180°, Solder pin length (l): 1.5 mm, tinned, Black, Box	4032248131068	20 pc(s).	IEC: 320 V / 15 A UL: 300 V / 10 A
SL-SMT 3.50/20/180G 3.2SN BK BX	<a href="#">1842490000</a>	PCB plug-in connector, male header, closed side, Reflow solder connection, 3.50 mm, No. of poles: 20, 180°, Solder pin length (l): 3.2 mm, tinned, Black, Box	4032248353842	20 pc(s).	IEC: 320 V / 15 A UL: 300 V / 10 A	Box

**OMNIMATE Signal - series BL/SL 3.50  
BL 3.50/20/90 SN BK BX**

**Weidmüller Interface GmbH & Co. KG**  
Klingenbergstraße 16  
D-32758 Detmold  
Germany  
Fon: +49 5231 14-0  
Fax: +49 5231 14-292083  
www.weidmueller.com

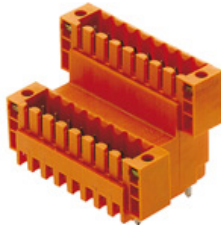
**Mating connector (conditionally pluggable)**
**SLD 3.50V/180F**

Double-level, staggered pin header for wave soldering at 3.50 mm pitch. They are available in closed and flanged versions. The male connectors provide space for labelling and can be coded.

**General ordering data**

Type	Order No.	Version	GTIN (EAN)	Qty.	Product data	Packaging
SLD 3.50 V/40/180F 3.2 SN OR BX	<a href="#">1641330000</a>	PCB plug-in connector, male header, Flange, Solder connection, 3.50 mm, No. of poles: 40, 180°, Solder pin length (l): 3.2 mm, tinned, Orange, Box	4008190279738	10 pc(s).	IEC: 200 V / 10.5 A UL: 300 V / 8 A	Box

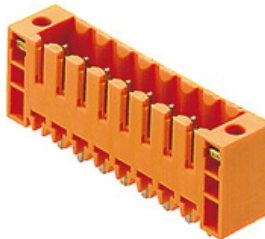
**SL 3.50/180F**

Pin headers for wave soldering in 3.50 mm pitch

- Plugging direction is parallel (90°), straight 180° or angled (135°) to the PCB
- Housing variant: screw flange (F)
- Packed in a cardboard box (BX)
- Pin header can be coded

**General ordering data**

Type	Order No.	Version	GTIN (EAN)	Qty.	Product data	Packaging
SL 3.50/20/180F 3.2SN OR BX	<a href="#">1622210000</a>	PCB plug-in connector, male header, Flange, Solder connection, 3.50 mm, No. of poles: 20, 180°, Solder pin length (l): 3.2 mm, tinned, Orange, Box	4008190188931	20 pc(s).	IEC: 320 V / 17 A UL: 300 V / 10 A	Box

**OMNIMATE Signal - series BL/SL 3.50  
BL 3.50/20/90 SN BK BX**

**Weidmüller Interface GmbH & Co. KG**  
Klingenbergstraße 16  
D-32758 Detmold  
Germany  
Fon: +49 5231 14-0  
Fax: +49 5231 14-292083  
www.weidmueller.com

**Mating connector (conditionally pluggable)**
**SLD 3.50V/90F**

Double-level, staggered pin header for wave soldering at 3.50 mm pitch. They are available in closed and flanged versions. The male connectors provide space for labelling and can be coded.

**General ordering data**

Type	Order No.	Version	GTIN (EAN)	Qty.	Product data	Packaging
SLD 3.50 V/40/90F 3.2 SN OR BX	<a href="#">1642460000</a>	PCB plug-in connector, male header, Flange, Solder connection, 3.50 mm, No. of poles: 40, 90°, Solder pin length (l): 3.2 mm, tinned, Orange, Box	4008190280987	10 pc(s).	IEC: 200 V / 10.5 A UL: 300 V / 8 A	Box

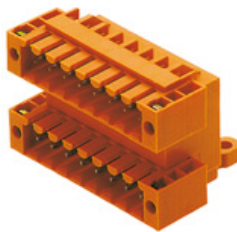
**SLD 3.50/90F**

Two-tier pin header for wave soldering in 3.50 mm pitch. The connector is available in open, closed and flange versions. The male connectors provide space for labelling and can be coded. Packed in a cardboard box.

**General ordering data**

Type	Order No.	Version	GTIN (EAN)	Qty.	Product data	Packaging
SLD 3.50/40/90F 3.2SN OR BX	<a href="#">1633990000</a>	PCB plug-in connector, male header, Flange, Solder connection, 3.50 mm, No. of poles: 40, 90°, Solder pin length (l): 3.2 mm, tinned, Orange, Box	4008190258443	10 pc(s).	IEC: 200 V / 10.5 A UL: 300 V / 8 A	Box

**OMNIMATE Signal - series BL/SL 3.50  
BL 3.50/20/90 SN BK BX**

**Weidmüller Interface GmbH & Co. KG**  
Klingenbergstraße 16  
D-32758 Detmold  
Germany  
Fon: +49 5231 14-0  
Fax: +49 5231 14-292083  
www.weidmueller.com

**Mating connector (conditionally pluggable)**
**SL-SMT 3.5/90LF Box**

**High-temperature-resistant male header, 3.50 mm pitch.**

- **Plugging direction parallel (90°), straight 180° or angled (135°) to PCB**
- **Housing variants: closed side (G), screw flange (F), solder flange (LF) or snap-on solder flange (RF)**
- **Optimised for the SMT process**
- **Pin length 3.2 mm universal for all soldering methods**
- **Pin length 1.5 mm optimised for reflow soldering methods**
- **Packed either in a box (BX) or tape-on-reel (RL)**
- **Male header can be coded**

**General ordering data**

Type	Order No.	Version	GTIN (EAN)	Qty.	Product data	Packaging
SL-SMT 3.50/20/90LF 3.2SN BK BX	<a href="#">1842030000</a>	PCB plug-in connector, male header, Solder flange, Reflow solder connection, 3.50 mm, No. of poles: 20, 90°, Solder pin length (l): 3.2 mm, tinned, Black, Box	4032248353385	20 pc(s).	IEC: 320 V / 15 A UL: 300 V / 10 A	Box
SL-SMT 3.50/20/90LF 1.5SN BK BX	<a href="#">1805120000</a>	PCB plug-in connector, male header, Solder flange, Reflow solder connection, 3.50 mm, No. of poles: 20, 90°, Solder pin length (l): 1.5 mm, tinned, Black, Box	4032248269020	20 pc(s).	IEC: 320 V / 15 A UL: 300 V / 10 A	Box

## OMNIMATE Signal - series BL/SL 3.50 BL 3.50/20/90 SN BK BX

**Weidmüller Interface GmbH & Co. KG**  
 Klingenbergstraße 16  
 D-32758 Detmold  
 Germany  
 Fon: +49 5231 14-0  
 Fax: +49 5231 14-292083  
 www.weidmueller.com

### Mating connector (conditionally pluggable)

#### SL-SMT 3.5/180LF Box



**High-temperature-resistant male header, 3.50 mm pitch.**

- **Plugging direction parallel (90°), straight 180° or angled (135°) to PCB**
- **Housing variants: closed side (G), screw flange (F), solder flange (LF) or snap-on solder flange (RF)**
- **Optimised for the SMT process**
- **Pin length 3.2 mm universal for all soldering methods**
- **Pin length 1.5 mm optimised for reflow soldering methods**
- **Packed either in a box (BX) or tape-on-reel (RL)**
- **Male header can be coded**

#### General ordering data

Available until	Type	Order No.	Version	GTIN (EAN)	Qty.	Product data
2014-05-20	SL-SMT 3.50/20/180LF 1.5SN BK BX	<a href="#">1804890000</a>	PCB plug-in connector, male header, Solder flange, Reflow solder connection, 3.50 mm, No. of poles: 20, 180°, Solder pin length (l): 1.5 mm, tinned, Black, Box	4032248268658	20 pc(s).	IEC: 320 V / 15 A UL: 300 V / 10 A
	SL-SMT 3.50/20/180LF 3.2SN BK BX	<a href="#">1842720000</a>	PCB plug-in connector, male header, Solder flange, Reflow solder connection, 3.50 mm, No. of poles: 20, 180°, Solder pin length (l): 3.2 mm, tinned, Black, Box	4032248354085	20 pc(s).	IEC: 320 V / 15 A UL: 300 V / 10 A



# Addresses worldwide

Let's connect.

- AE United Arab Emirates**  
Weidmüller Middle East FZE  
Warehouse Q3-79  
SAIF-Zone  
P.O. BOX 8591  
Sharjah  
Telephone number +971 65572723  
Fax number +971 65572724  
wme.info@weidmuller.com
- AO Angola**  
Please contact  
Phambili Interface  
South Africa
- AR Argentina**  
CPI SA  
Bauness 2660  
C1431DOF Buenos Aires  
Telephone number +54 11 4523 8008  
Fax number +54 11 4522 0546  
info@cpi.com.ar  
www.cpi.com.ar
- AT Austria**  
Weidmüller GmbH  
IZ NOE Süd Straße 2b, Obj  
M 59  
2355 Wiener Neudorf  
Telephone number +43 2236 67080  
Fax number +43 2236 6708-899  
office.at@weidmuller.com  
www.weidmuller.com
- AU Australia**  
Weidmüller Pty. Ltd.  
PO BOX 6944  
Huntingwood 2148  
Huntingwood Drive 43  
Huntingwood NSW 2148  
Telephone number +61 2 9671 9999  
Fax number +61 2 9671 9911  
info@weidmuller.com.au  
www.weidmuller.com.au
- AZ Azerbaijan**  
Representative Office  
Rashad Mahmudov  
Demirchi Tower, 4th floor  
37, Khojali ave.  
AZ 1025 Baku  
Telephone number +994 12 488 80 36  
Fax number +994 12 488 80 37  
rashad.mahmudov@weidmuller.com
- BA Bosnia and Herzegovina**  
Please contact  
our Representative Office  
Weidmüller Interface GmbH  
& Co. KG  
Serbia
- or
- BIG electric d.o.o  
Mladena Stojanovića 117A  
78000 Banja Luka  
Telephone number +387 51926277  
Fax number +387 51926277  
bigelectric@blic.net  
www.bigelectric.ba
- BE Belgium**  
Weidmüller Benelux B. V.  
Mechelsesteenweg 519 bus  
6 en 7  
1930 Nossegem  
Telephone number +32 2 752 40 70  
Fax number +32 2 751 36 06  
info@weidmuller.be  
www.weidmuller.be
- BG Bulgaria**  
Weid-Bul EOOD  
Bul. "Kliment Ohridski" 13  
1756 Sofia  
Telephone number +359 2 963 2560  
Fax number +359 2 963 1098  
sofia@weidbul.com  
www.weidbul.com
- BH Bahrain**  
Khayber Trading Company  
P.O Box 1976  
Manama  
Telephone number +973 720747  
Fax number +973 720331  
khayber@batelco.com.bh
- BR Brazil**  
Weidmüller Conexel do Brasil  
Conexões Elétricas Ltda.  
Av. Presidente Juscelino, 642  
- Piraporinha  
Diadema, São Paulo  
09950-370  
Telephone number +55 (11) 4366-9600  
Fax number +55 (11) 4362-1677  
vendas@weidmuller.com.br  
www.weidmuller.com.br
- BW Botswana**  
Please contact  
Phambili Interface  
South Africa
- BY Belarus**  
TECHNIKON Ltd.  
Nezavisimosti pr. 177-9  
220125 Minsk  
Telephone number +375 17 393-11-77  
Fax number +375 17 3930080  
wm@technikon.by
- CA Canada**  
W Interconnections Canada  
Inc.  
10 Spy Court  
Markham Ontario L3R 5H6  
Telephone number +1 (905) 475-1507 Ext. 9836  
Fax number +1 (905) 475-2798  
support@weidmuller.ca  
www.weidmuller.ca
- CG Congo**  
Please contact  
Phambili Interface  
South Africa
- CH Switzerland**  
Weidmüller Schweiz AG  
Rundbuckstraße 2  
82 12 Neuhausen am  
Rheinfall SH  
Telephone number +41 52 674 07 07  
Fax number +41 52 674 07 08  
info@weidmuller.ch  
www.weidmuller.ch
- CL Chile**  
ATS - INTECH  
Maria Luisa Santander 0475  
Santiago  
Providencia 7500859  
Telephone number +56 2 341 1271  
Fax number +56 2 341 1275  
felipe@atsintech.com  
www.atsintech.com
- CPI CHILE LTDA  
Av. Presidente Frei Montalva  
6001, 47 complejo el cortijo  
Santiago - Conchalí  
Telephone number +562 963 8440  
Fax number +562 963 8440  
cpi@cpihile.cl  
www.cpihile.cl
- CN China**  
Weidmüller Interface  
(Shanghai) Co. Ltd.  
100 Yutong Road  
25 F. BM Intercontinental  
Business Center  
200070 Shanghai  
Telephone number +86 21-22195008  
Fax number +86 512-68417505  
customer.hotline@weidmuller.com.cn  
www.cnweidmuller.com
- CO Colombia**  
Automatización Avanzada  
S. A.  
Carrera 97 No., 24 c - 23  
Bodega 4  
110911 Bogotá-D.C.  
Telephone number +57 (1) 547-8510  
Fax number +57 (1) 422-3044  
comercial@automatizacionavanzada.com  
www.automatizacionavanzada.com
- CR Costa Rica**  
ELVATRON S. A.  
la Uruca 400 Norte Banco  
Costa Rica  
San Jose Costa Rica  
Telephone number +506 2961-060  
Fax number +506 5200-609  
dirk.haase@elvatron.com  
www.elvatron.com
- CZ Czech Republic**  
Weidmüller s.r.o.  
Lomnického 5/1705  
140 00 Praha 4  
Telephone number +420 244 001 400  
Fax number +420 244 001 499  
office@weidmuller.cz  
www.weidmuller.cz
- DE Germany**  
Weidmüller GmbH & Co. KG  
Ohmstraße 9  
32758 Detmold  
Postfach 30 54  
32720 Detmold  
Telephone number +49 5231 1428-0  
Fax number +49 5231 14-292083  
weidmuller@weidmuller.de  
www.weidmuller.de
- DK Denmark**  
Weidmüller Danmark  
Vallensbækvej 18A  
2605 Brøndby  
Telephone number +45 27747800  
kundeservice@weidmuller.dk  
www.weidmuller.dk
- EC Ecuador**  
Elsystec S. A., Electricidad  
Sistemas y Tecnología  
Vasco de Contreras N35-251  
y Mañosa  
Quito - Pichincha  
Telephone number +593 22456510  
Fax number +593 22456755  
Elsystec@uiio.satnet.net
- EE Estonia**  
Please contact  
our Representative Office  
Weidmüller Interface GmbH  
& Co. KG  
Latvia
- or
- Soots Interface OÜ  
Pärnu mnt 142  
11317 Tallinn  
Telephone number +372 609 6933  
Fax number  
info@sootsinterface.ee  
www.sootsinterface.ee
- EG Egypt**  
Standard Electric (OMEGA)  
87, Mohamed Farid Street  
Heliopolis  
Cairo  
Telephone number +202 26229000  
Fax number +202 26221555  
stdelec@rite.com
- ES Spain**  
Weidmüller, S. A.  
Narcis Monturiol 11-13, Pol.  
Ind. Sudoeste  
8960 Sant Just  
Desvern - Barcelona  
Telephone number +34 934 803 386  
Fax number +34 933 718 055  
weidmuller@weidmuller.es  
www.weidmuller.es
- FI Finland**  
Weidmüller Suomi,  
Weidmüller Aktiebolagetin  
sivuliike  
Koy Plaza Vivace  
Äyritie 8C  
FI 1510 Vantaa  
Telephone number +358 20 7351300  
Fax number +358 800 114 667  
asiakaspalvelu@weidmuller.fi  
www.weidmuller.fi
- FR France**  
Weidmüller E. U. R. L.  
12, Chaussée Jules César  
BP 263 Osny  
95523 Cergy-Pontoise Cedex  
Telephone number +33 1 34 24 55 00  
Fax number +33 1 34 24 55 01  
mail@weidmuller.fr
- GB Great Britain**  
Weidmüller Ltd.  
Klippon House  
Centurion Court Office Park,  
Meridian East, Meridian  
Business Park  
Leicester  
LE19 1TP  
Telephone number +44 116 282 3470  
Fax number +44 116 289 3582  
marketing@weidmuller.co.uk  
www.weidmuller.co.uk
- GE Georgia**  
Please contact  
our Representative Office  
Rashad Mahmudov  
Azerbaijan.
- GR Greece**  
G.A. Solutions  
Ippokratous 11 Metamorfosi  
144 52 Athen  
Telephone number +30 210 2823233  
Fax number +30 210 2823233  
info@weidmuller.gr  
www.weidmuller.gr
- GT Guatemala**  
Prestelectro, Prestegard  
Electro, S.A.  
Avenida Petapa 44-22,  
Zona 12  
Guatemala City  
Telephone number +502 2442-3346  
Fax number +502 2476-8945  
ventas@preselectro.com
- HK Hong Kong**  
Weidmüller (Hong Kong)  
Limited Co. Ltd.  
Unit 1617, Metropolis Tower  
No. 10 Metropolis Drive,  
Hung Hom, Kowloon  
Telephone number +852 3154 8088  
Fax number +852 31548099  
Info-hk@weidmuller.com.hk
- HR Croatia**  
ElektroPARTNER d.o.o.  
Slavonska avenija 24/6  
HR-10000 Zagreb  
Telephone number +385 (1) 6184 793  
Fax number +385 (1) 6184 795  
elektropartner@zg.t-com.hr  
www.elektropartner.hr
- HU Hungary**  
Weidmüller Kereskedelmi Kft.  
Budapest  
Gubacsi út 6.  
1097  
Telephone number +36 1 382 7700  
Fax number +36 1 382 7701  
info@weidmuller.hu  
www.weidmuller.hu
- ID Indonesia**  
PT. Nego Electrindo  
Ruko Mega Grosir Cempaka  
Mas Blok 1 No. 20 - 22  
Jakarta 10640  
Telephone number +62 21 42882255  
Fax number +62 21 42882266  
sales@negoelectrindo.co.id
- IE Ireland**  
Please contact  
Weidmüller Ltd.  
Great Britain
- IL Israel**  
A. U. Shay Ltd.  
23/25, Embar Street  
49222 Petach-Tikva  
P.O. Box 1 00 49  
49222 Petach-Tikva  
Telephone number +972 3-923-3601  
Fax number +972 3-923-4601  
shay@uriel-shay.com  
www.uriel-shay.com
- ATEKA Ltd.  
4, Ha Tavor lane Industrial  
area Segula  
49691 Petach-Tikva  
P.O. Box 4710  
Petach-Tikva  
Telephone number +972 73-200-1311  
Fax number +972 3-924 4245  
marketing@ateka.co.il  
www.ateka.co.il
- IN India**  
Representative Office  
Weidmüller Electronics India  
Pvt. Ltd.  
12th Lane North Avenue, Opp  
Joggers Park,  
Kalyani Nagar, Pune  
411 006  
Telephone number +91 20-41290090  
Ntish.Rajan@weidmuller.de  
www.weidmuller.com
- IS Iceland**  
Samey Automation Center  
Lyngas 13  
210 Garabaer  
Telephone number +354 510 5200  
Fax number +354 510 5201  
Samey@samey.is  
www.samey.is
- IT Italy**  
Weidmüller S. r.l.  
Via Albert Einstein 4  
20092 Cinisello  
Balsamo Milano  
Telephone number +39 02 660681  
Fax number +39 02 6124945  
weidmuller@weidmuller.it  
www.weidmuller.it
- JM Jamaica**  
Please contact  
W Interconnections Inc.  
United States
- JO Jordan**  
Trans Jordan for Electro  
PO Box 33 06 07  
Amman  
Telephone number +962 6 533 2020  
Fax number +962 6 533 5800  
transjordan@batelco.jo
- JP Japan**  
Nihon Weidmüller Co. Ltd.  
Sphere Tower Tennoz 2-2-8  
Higashi-Shinagawa,  
Shinagawa-ku  
Tokyo  
140-0002  
Telephone number +81 3 6711 5300  
Fax number +81 3 6711 5333  
weidmullerjapan@weidmuller.com.jp  
www.weidmuller.co.jp



You can find all Weidmüller addresses and your local contact on the internet at: [www.weidmuller.com/countries](http://www.weidmuller.com/countries)

Sales company 

Representation abroad 

without representation abroad 

Let's connect.

- KE Kenya**  
Please contact  
Phambili Interface  
South Africa
- KR Korea**  
Weidmüller Korea Co. Ltd.  
9th floor, Wonbang B/D  
Samseong 2-Dong, Gangnam-Gu  
Seoul 143-42  
Telephone number +82 2-516-0003  
Fax number +82 2-516-0090  
info@weidmuller.co.kr  
www.weidmuller.co.kr
- KW Kuwait**  
Kana Controls General Trading & Contracting Co. W. L. L.  
Al Rai Industrial Area, Plot 28-30, St. 31  
13016 Safat  
B.P. 25593  
Telephone number +965 4741373  
Fax number +965 4741537  
info@kanacontrols.com
- KZ Kazakhstan**  
Please contact  
OOO Weidmüller  
Russia
- LB Lebanon**  
Progress Engineering & Trading Enterprises  
Al Nahr Street  
Beirut 11-1111  
Telephone number +961 1 444 664  
Fax number +961 1 561 880  
progress@inco.com.lb
- LT Lithuania**  
Please contact  
our Representative Office  
Weidmüller Interface GmbH & Co. KG  
Latvia  
or  
ELEKTROS IRANGA  
Tinklų g. 29 a  
LT-5319 Panevezys  
Telephone number +370 (45) 582 828  
Fax number  
info@eliranga.lt
- LU Luxembourg**  
Please contact  
Weidmüller Benelux B. V.  
Netherlands
- LV Latvia**  
SIA Abi4  
Daugavgrīvas 31b  
Rīga, LV-1007  
Telephone number +371 674 70999  
Fax number +371 676 24562  
abi\_4@tvnet.lv  
Representative Office  
Weidmüller Interface GmbH & Co. KG  
Udens str. 12-118  
Rīga, LV-1007  
Telephone number +371 29254766  
Fax number +371 674 65637  
lgonis.rudaks@weidmueller.com  
www.weidmueller.com
- MD Moldova**  
BERHORD A & D srl  
79/1, str. Milescu Spartaru  
MD-2075 Chisinau  
Moldova  
Telephone number +373 (22) 815002  
Fax number +373 (22) 815007  
atiuleanu@berhord.com  
www.ad.berhord.com
- ME Montenegro**  
Please contact  
our Representative Office  
Weidmüller Interface GmbH & Co. KG  
Serbia.
- MG Madagascar**  
Please contact  
Phambili Interface  
South Africa
- MK Macedonia**  
Please contact  
our Representative Office  
Weidmüller Interface GmbH & Co. KG  
Serbia  
or  
ELEKTRO - SMK doool  
UL. III Makedonska brigada  
b.b.  
1000 Skopje  
Telephone number +389 22460295  
Fax number  
Elektro-smk@telekabel.net.mk
- MT Malta**  
E. S. S., Electrical Supplies & Services Ltd.  
San Gwakkinn Road  
Mrieħel  
Telephone number +356 21255777  
Fax number +356 21255999  
robert.agius@ess.com.mt
- MU Mauritius**  
Mubelo Electrical Ltd.  
Office 26, Gateway building,  
St Jean Road  
Quatre Bornes  
Mauritius  
Telephone number +230 4670989  
Fax number +230 4654051  
richard.mubelo@orange.mu
- MW Malawi**  
Please contact  
Phambili Interface  
South Africa
- MX Mexico**  
W Interconnections S. A.  
DE C. V.  
Blvd. Hermanos Serdán 698,  
Col. San Rafael Oriente  
72029 Puebla  
Telephone number +52 (222) 268 6227  
Fax number +52 (222) 286 6242  
clientes@weidmuller.com.mx
- MY Malaysia**  
Connect Plus Technology  
Sdn Bhd  
No. 43, Jalan PJS 11/22,  
Bandar Sunway  
46150 Petaling Jaya  
Selangor Darul Ehsan  
Telephone number +60 3 5633 7363  
Fax number +60 3 5633 6562  
paul@cptech.com.my  
www.cptech.com.my
- MZ Mozambique**  
Please contact  
Phambili Interface  
South Africa
- NA Namibia**  
Please contact  
Phambili Interface  
South Africa
- NG Nigeria**  
Please contact
- NL Netherlands**  
Weidmüller Benelux B. V.  
Franciscusweg 221  
1216 SE Hilversum  
P.O. Box 1505  
1200 BM Hilversum  
Telephone number +31 35 826 12 61  
Fax number +31 35 623 20 44  
info@weidmuller.nl  
www.weidmuller.nl
- NO Norway**  
Sivilingeniør J.F. Knudtzen AS  
Billingstadsletta 97  
1396 Billingstad  
PO Box 160  
1378 Nesbru  
Telephone number +47 66 98 33 50  
Fax number +47 66 98 09 55  
firmapost@jfknuudtzen.no  
www.jfknuudtzen.no
- NZ New Zealand**  
Cuthbert S. Steward Ltd.  
27 Te Puni Street  
Petone  
PO Box 38496  
Wellington Mail Centre 5054  
Telephone number (04) 568 6156  
Fax number (09) 489 1752  
csl@cuthbertsteward.co.nz  
Cuthbert S. Steward Ltd  
4 Fred Thomas Drive  
Aon Building, Ground Floor,  
South Entry  
Takapuna  
PO Box 100 338  
North Shore City 745  
Telephone number (09) 489 1751  
Fax number (04) 568 6056  
cslak@cuthbertsteward.co.nz
- OM Oman**  
DAN INTERNATIONAL LLC.  
Ghala St. 111  
BP 2901  
Seeb  
Telephone number +968 5036 77  
Fax number +968 5037 55  
yedu@danintl.com
- PE Peru**  
IMPEXINCA S.A.C.  
Calle Ortiz de Zevallos No.  
105, Urb. San Antonio  
18  
Lima, Miraflores  
Telephone number +51 1 447 5608  
info@impexinca.pe  
www.impexinca.pe  
J & W CIA. S. A.  
Calle 6 Mz. D Lte. 23, Urb.  
Ind. Grimanesa  
01  
Callao  
Telephone number +51 1 572 2539  
Fax number +51 1 572 0152  
contacto@jwcia.com  
www.jwcia.com
- PH Philippines**  
Enclosure Systems Specialists  
Inc.  
2276 Don Chino Roces  
Avenue Extension  
Room 103/105 Narra Building  
1231 Makati City  
Telephone number +63 2 813 8580  
Fax number +63 2 813 8596  
sales\_encsys@pltdsl.net  
www.enclosuresystemsph.com
- PK Pakistan**  
Automation Controls (Pak)  
Apartment No. 33 C III,  
Chenab Block, Allama Iqbal  
Town  
Lahore  
Telephone number +92 42 37809948  
Fax number +92 42 37809950  
nadeem@acpak.com.pk  
www.acpak.com.pk
- PL Poland**  
Weidmüller Sp. z o. o.  
ul. Ogrodowa 58  
00-876 Warszawa  
Telephone number +48 22 510 09 40  
Fax number +48 22 510 09 41  
biuro@weidmuller.com.pl  
www.weidmuller.pl
- PR Puerto Rico**  
Please contact  
W Interconnections Inc.  
United States
- PT Portugal**  
Weidmüller Sistemas de Interface S. A.  
Estrada Outeiro Polima, R.  
Augusto Dias da Silva, Lote B - Esct. 2  
São Domingos de Rana  
2785-515 Abóboda  
Telephone number +351 214 459 191  
Fax number +351 214 455 871  
weidmuller@weidmuller.pt  
www.weidmuller.pt
- PY Paraguay**  
Please contact  
CPI SA  
Argentina
- QA Qatar**  
Petroleum Technology Co.  
W.L.L.  
PO Box 16069  
5th Floor Toyota tower  
Telephone number +974 444 19603  
Fax number +974 444 19604  
petrotec@qatar.net.qa  
www.petrotec.com.qa
- RO Romania**  
Representative Office  
Weidmüller Interface GmbH & Co. KG  
Ionescu Crum Street, No.  
1, 1st Tower, 1st Floor,  
Office 4  
500446 Brasov - Brasov  
Business Park  
Telephone number +40 (268) 446 222  
Fax number +40 (262) 205 410  
claudiu.totea@weidmueller.com  
www.weidmueller.com
- RS Serbia**  
Representative Office  
Weidmüller Interface GmbH & Co. KG  
Ustanička 189, III sprat  
lokal 7a  
11050 Beograd  
Telephone number +381 112885274  
Fax number +381 112885274  
zoran.rabrenovic@weidmueller.com  
TeLa Elektrik d.o.o.  
Ul. Dr. Drage Ljočić 6  
Beograd  
Telephone number +381 11 2772 850  
Fax number +381 11 2772 850  
office@tela.rs  
www.tela.rs
- RU Russia**  
OOO Weidmüller  
Warszavskoye highway, 25  
A, bld. 6  
Moskau  
117105  
Telephone number +7 (495) 771-69-40  
Fax number +7 (495) 771-69-41  
Info@weidmueller.ru  
www.weidmueller.ru
- SA Saudi Arabia**  
Al Abdulkarim Holding Co.  
P.O. Box 4  
Dammam 31411  
Telephone number +966 3 8337110  
Fax number +966 3 8829547  
E-mail salehsk@akh.com.sa  
www.weidmueller.ae  
Saudi Electric Supply  
Company (SESCO)  
P.O. Box 32 98  
Al Khobar 31952  
Telephone number +966 3 8829546 Ext. 3030  
Fax number  
E-mail Safdar.Malik@sescogex.com  
www.sesco-gex.com
- SE Sweden**  
Weidmüller AB  
Axel Danielssons väg 271  
BOX 3 1025  
SE-200 49 Malmö  
Telephone number +46 77-143 00 44  
Fax number +46 40-37 48 60  
info@weidmuller.se  
www.weidmuller.se
- SG Singapore**  
Weidmüller Pte. Ltd.  
70 Bendemeer Road  
# 04-03 Luzerne Building  
Singapore 339940  
Telephone number +65 6841 5311  
Fax number +65 6841 5377  
info@weidmuller.com.sg  
www.weidmuller.com.sg
- SI Slovenia**  
Elektrospoji d. o. o.  
Stegne 27  
SI-1000 Ljubljana  
Osrednjelosovska  
Telephone number +386 1 511 3810  
Fax number +386 1 511 1604  
info@elektrospoji.si  
www.elektrospoji.si
- SK Slovakia**  
ELEKTRIS s.r.o.  
Elektrárenská 1  
831 04 Bratislava  
Telephone number +421 2/4920 0113  
Fax number +421 2/4920 0119  
bratislava@elektris.sk
- SV El Salvador**  
Prestegard Electro  
11 Avenida Norte No. 240  
Edificio Salazar No. 2  
San Salvador  
Telephone number +503 2271 1690  
Fax number +503 2221 3851  
prestegard@navegante.com.sv
- SY Syria**  
Please contact  
Weidmüller Middle East FZE  
United Arab Emirates
- SZ Swaziland**  
Please contact  
Phambili Interface  
South Africa
- TH Thailand**  
Pisanu Engineering Co. Ltd.  
Kwang Dingaeng, Khet  
Dingaeng  
800/2 Soi Trakulsuk, Asoke-  
dindaeng Road  
Dindaeng, Bangkok  
10400  
Telephone number +66 2 248 2896  
Fax number +662 105 6301  
ecsales@pisanu.co.th  
www.pisanu.co.th  
Representative Office  
Weidmüller Pte. Ltd.  
37/F, Sathorn Square Building  
98 North Sathorn Road  
Bangkok, Silom Bangrak  
10500  
Telephone number +66 2 105 6300  
Fax number +66 2 642 9220  
info@weidmuller.com.sg
- TN Tunisia**  
Please contact  
Weidmüller E. U. R. L.  
France
- TR Turkey**  
Weidmüller Elektronik Ticaret  
Ltd. Sirketi  
Kavacık Mah. Orhan Veli Kanik  
Cadidesi 9/1  
34810 Beykoz / Istanbul  
Telephone number +90 (216) 537 10 70  
Fax number +90 (216) 537 10 77  
info@weidmuller.com.tr  
www.weidmuller.com.tr

# Addresses worldwide

Let's connect.

**TW Taiwan**  
Weidmuller (Hong Kong)  
Limited  
No. 3, Lane 89, ChungYang  
N. Rd  
24148 SanChuang City,  
Taipei  
Telephone number +886 921  
949 751  
roy.lin@weidmueller.com.hk

**TZ Tanzania**  
Please contact  
Phambili Interface  
South Africa

**UA Ukraine**  
LLC WM UKRAINE  
Levanevskogo str. 6  
Kiev  
3058  
Telephone number +38 044  
490 32 48  
Fax number  
info@wm-ua.com.ua  
wm-ua.com.ua/

Representative Office  
Weidmuller Interface GmbH  
& Co. KG  
Z. office 303  
7-D, Zdolbunivska str.  
Kiev, 2081  
Telephone number  
(mobile) +38 050 440 25 24  
info.ua@weidmueller.com

**US United States**  
W Interconnections Inc.  
821 Southlake Boulevard  
Richmond Virginia 23236  
Telephone number +1 (804)  
794-2877  
Fax number +1 (804) 379-  
2593  
info@weidmuller.com  
www.weidmuller.com

**UY Uruguay**  
REWO Uruguay S. A.  
AV. Bolivia 2001Esq  
Rocafuerte  
11300 Carrasco Montevideo  
Telephone number +598  
2604 8439  
Fax number +598 2604  
8439  
rewo@rewouruguay.com.uy

**UZ Republic of Uzbekistan**  
Please contact  
OOO Weidmüller  
Russia

**VE Venezuela**  
Somerinca C. A.  
Corazon de Jesus - 3ra  
Transversal con calle el  
Carmen- Los Dos Caminos  
Caracas 1070-A  
Telephone number +58  
2122352748  
Fax number +58  
2122399341  
klocmoeller@cantv.net  
www.somerinca.com

**VN Vietnam**  
AUMI Industrial Equipment &  
Automation Company Limited  
E1, La Thanh Hotel  
218 Doi Can Street  
Lieu Gial Ward, Ba Dinh  
District  
Hanoi City  
Telephone number +84 4  
37628601  
Fax number +84 4  
62661391  
aumi@aumi.com.vn  
www.aumi.com.vn

Representative Office  
Weidmüller Pte. Ltd.  
Level 16 Saigon Tower  
Building  
29 Le Duan Street  
District 1  
Ho Chi Minh  
Telephone number +848  
3520 7717  
Fax number +848 3520  
7604  
info@weidmuller.com.sg

**ZA South Africa**  
Phambili Interface  
PO Box 193  
1609 Johannesburg, Edenvale  
5 Bundo Road, Sebenza  
1610 Johannesburg  
Telephone number +27 (11)  
4521930  
Fax number  
info@weidmuller.co.za  
www.weidmuller.co.za

**ZM Zambia**  
Please contact  
Phambili Interface  
South Africa

**ZW Zimbabwe**  
Please contact  
Phambili Interface  
South Africa

