

OMNIMATE Signal - series BLA/SLA 5.08 SLA 08/90 3.2SN OR BX

Weidmüller Interface GmbH & Co. KG
Klingenbergstraße 16
D-32758 Detmold
Germany
Fon: +49 5231 14-0
Fax: +49 5231 14-292083
www.weidmueller.com

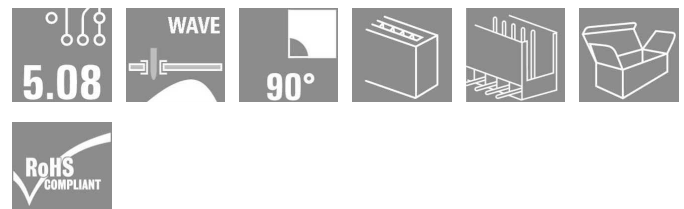

Dimensionally stable, angled, codable male connector from the Unimate range of plugs with integral aid to prevent wrong connections. Available with open or closed sides. Fixing blocks can be attached to the closed version. The solder pin length of 3.2 mm has been optimised for wave soldering. Supplied in cardboard box.

- 400 V (IEC) / 300 V (UL)
- 17.5 A (IEC) / 10 A (UL)

General ordering data

Type	SLA 08/90 3.2SN OR BX
Order No.	1238660000
Version	PCB plug-in connector, male header, open side, Solder connection, 5.08 mm, No. of poles: 8, 90°, Solder pin length (l): 3.2 mm, tinned, Orange, Box
GTIN (EAN)	4008190022853
Qty.	50 pc(s).
Product data	IEC: 400 V / 17.5 A UL: 300 V / 10 A
Packaging	Box

OMNIMATE Signal - series BLA/SLA 5.08
SLA 08/90 3.2SN OR BX

Weidmüller Interface GmbH & Co. KG
 Klingenbergstraße 16
 D-32758 Detmold
 Germany
 Fon: +49 5231 14-0
 Fax: +49 5231 14-292083
 www.weidmueller.com

Technical data

Dimensions and weights

Net weight 3.98 g

System parameters

Product family	OMNIMATE Signal - series BLA/SLA 5.08	Mounting onto the PCB	Solder connection
Outgoing elbow	90°	Pitch in mm (P)	5.08 mm
Pitch in inches (P)	0.2 inch	No. of poles	8
Solder pin length (l)	3.2 mm	Solder pin dimensions	d = 1.2 mm, Octagonal
Can be coded	Yes	Number of solder pins per pole	1
Solder eyelet hole diameter (D)	1.3 mm	Solder eyelet hole diameter tolerance (D)	+ 0,1 mm
L1 in mm	35.56 mm	L1 in inches	1.4 inch
Insulation resistance	≥ 10 ⁸ Ω	Touch-safe protection acc. to DIN VDE 57 106	Safe from back-of-hand touch
Volume resistance	5.50 mΩ		

Material data

Insulating material	PBT GF	Colour	Orange
Insulating material group	IIIa	UL 94 flammability rating	V-0
CTI	≥ 200	Contact material	CuSn
Contact surface	tinned	Operating temperature, min.	-50 °C
Operating temperature, max.	120 °C	Temperature range, installation, min.	-25 °C
Temperature range, installation, max.	120 °C	Max. relative humidity during storage	80 %

Rating data acc. to IEC 60664-1 / IEC 61984

Rated current, min. no. of poles (Tu=20°C)	17.5 A	Rated current, max. no. of poles (Tu=20°C)	12.5 A
Rated current, number of poles (Tu=40°C), min	16 A	Rated current, number of poles (Tu=40°C), max.	11 A
Rated voltage for surge voltage class / pollution degree III/3	250 V	Rated impulse voltage for surge voltage class/ contamination degree III/3	4 kV
Rated voltage for surge voltage class / pollution degree III/2	320 V	Rated impulse voltage for surge voltage class/ pollution degree III/2	4 kV
Rated voltage for surge voltage class / pollution degree II/2	400 V	Rated impulse voltage for surge voltage class/ pollution degree II/2	4 kV
Short-time withstand current resistance	3 x 1s with 100 A		

CSA rating data

Institute (CSA)		Certificate No. (CSA)	12400-158
Rated voltage (Use group B)	300 V	Rated current (use group B)	10 A
Rated voltage (use group D)	300 V	Rated current (use group D)	10 A

Data sheet

**OMNIMATE Signal - series BLA/SLA 5.08
SLA 08/90 3.2SN OR BX**

Weidmüller Interface GmbH & Co. KG
Klingenbergstraße 16
D-32758 Detmold
Germany
Fon: +49 5231 14-0
Fax: +49 5231 14-292083
www.weidmueller.com

Technical data

UL 1059 rating data

Institute (UR)		Certificate No. (UR)	
		E60693	
Rated voltage (use group B)	300 V	Rated current (use group B)	10 A
Rated voltage (use group D)	300 V	Rated current (use group D)	10 A

Classifications

ETIM 3.0	EC001284	ETIM 4.0	EC002637
ETIM 5.0	EC002637	ETIM 6.0	EC002637
UNSPSC	30-21-18-10	eClass 5.1	27-26-07-04
eClass 6.2	27-26-07-04	eClass 7.1	27-44-04-02

Notes

Notes	<ul style="list-style-type: none"> • Additional colours on request • Gold-plated contact surfaces on request • Rated current related to rated cross-section & min. No. of poles. • P on drawing = pitch • Rated data refer only to the component itself. Clearance and creepage distances to other components are to be designed in accordance with the relevant application standards.
IPC conformity	The products are developed, manufactured and delivered according to the internationally recognised IPC-A-610 standard, category "permissible". More extensive demands on the products can be evaluated on request.

Approvals

Approvals	   
ROHS	Conform

Downloads

CAD Library (P-CAD Format - ASCII)	SLA.zip
CAD Library (P-CAD Format - Standard)	SLA.zip
3-D model	

Data sheet**OMNIMATE Signal - series BLA/SLA 5.08
SLA 08/90 3.2SN OR BX**

Weidmüller Interface GmbH & Co. KG
Klingenbergstraße 16
D-32758 Detmold
Germany
Fon: +49 5231 14-0
Fax: +49 5231 14-292083
www.weidmueller.com

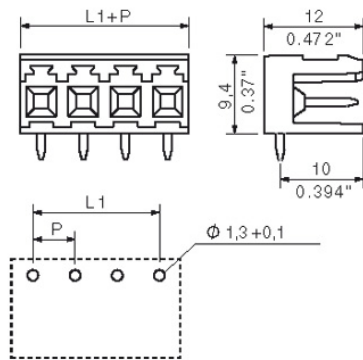
Drawings

**OMNIMATE Signal - series BLA/SLA 5.08
SLA 08/90 3.2SN OR BX**

Weidmüller Interface GmbH & Co. KG
Klingenbergstraße 16
D-32758 Detmold
Germany
Fon: +49 5231 14-0
Fax: +49 5231 14-292083
www.weidmueller.com

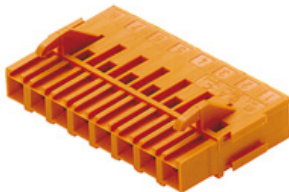
Mating connector (conditionally pluggable)
BLAC BR

Female header with crimp connection system enable rational prefabrication of cable looms and guarantee a distinct cost-saving. The BLAC is also available with dovetail (B) for convenient attachment of fixing blocks. Supplied in cardboard box.

- 0.22 - 2.5 mm² (IEC) / 26 - 14 AWG (UL)
- 500 V (IEC) / 300 V (UL)
- 20 A (IEC) / 10 A (UL)

General ordering data

Type	Order No.	Version	GTIN (EAN)	Qty.	Product data	Packaging
BLAC 8BR OR	1479160000	PCB plug-in connector, female plug, 5.08 mm, No. of poles: 8, 180°, Crimp connection, Clamping range, rated connection, max.: 2.5 mm ² , Box	4008190116828	50 pc(s).	IEC: 500 V / 20 A UL: 300 V / 10 A / AWG 26 - AWG 14	Box

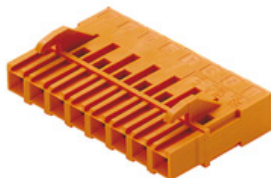
BLAC R

Female header with crimp connection system enable rational prefabrication of cable looms and guarantee a distinct cost-saving. The BLAC is also available with dovetail (B) for convenient attachment of fixing blocks. Supplied in cardboard box.

- 0.22 - 2.5 mm² (IEC) / 26 - 14 AWG (UL)
- 500 V (IEC) / 300 V (UL)
- 20 A (IEC) / 10 A (UL)

General ordering data

Type	Order No.	Version	GTIN (EAN)	Qty.	Product data	Packaging
BLAC 8R OR	1478260000	PCB plug-in connector, female plug, 5.08 mm, No. of poles: 8, 180°, Crimp connection, Clamping range, rated connection, max.: 2.5 mm ² , Box	4008190107857	50 pc(s).	IEC: 500 V / 20 A UL: 300 V / 10 A / AWG 26 - AWG 14	Box

**OMNIMATE Signal - series BLA/SLA 5.08
SLA 08/90 3.2SN OR BX**

Weidmüller Interface GmbH & Co. KG
Klingenbergstraße 16
D-32758 Detmold
Germany
Fon: +49 5231 14-0
Fax: +49 5231 14-292083
www.weidmueller.com

Mating connector (conditionally pluggable)
BLAT B

Female connectors with TOP connection system enable the clamping screw to be tightened parallel with the wire and so result in a high connection density. Also available with dovetail (B) for convenient attachment of fixing blocks. The BLAT has a labelling panel and can be coded. Supplied in cardboard box.

- 0.20 - 2.5mm² (IEC) / 26 - 14 AWG (UL)
- 400 V (IEC) / 300 V (UL)
- 15 A (IEC) / 10 A (UL)

General ordering data

Type	Order No.	Version	GTIN (EAN)	Qty.	Product data	Packaging
BLAT 8B SN OR	1487160000	PCB plug-in connector, female plug, 5.08 mm, No. of poles: 8, 180°, TOP connection, Clamping range, rated connection, max.: 2.5 mm ² , Box	4008190158019 42 pc(s).		IEC: 400 V / 15 A / 0.2 - 2.5 mm ² UL: 300 V / 10 A / AWG 26 - AWG 14	Box

BLA B

Female header with clamping yoke connection system. The principle of the vibration-proof screw connection and the Unimate range pin arrangement provides a unique security during operation. Also available with dovetail (B) for convenient attachment of fixing blocks. The BLA has a labelling panel and can be coded. Supplied in cardboard box.

- 0.20 - 2.5mm² (IEC) / 26 - 12 AWG (UL)
- 400 V (IEC) / 300 V (UL)
- 17.5 A (IEC) / 10 A (UL)

General ordering data

Type	Order No.	Version	GTIN (EAN)	Qty.	Product data	Packaging
BLA 8B SN OR	1356660000	PCB plug-in connector, female plug, 5.08 mm, No. of poles: 8, 180°, Clamping yoke connection, Clamping range, rated connection, max.: 3.32 mm ² , Box	4008190096793 42 pc(s).		IEC: 400 V / 17.5 A / 0.2 - 2.5 mm ² UL: 300 V / 10 A / AWG 26 - AWG 12	Box

**OMNIMATE Signal - series BLA/SLA 5.08
SLA 08/90 3.2SN OR BX**

Weidmüller Interface GmbH & Co. KG
Klingenbergstraße 16
D-32758 Detmold
Germany
Fon: +49 5231 14-0
Fax: +49 5231 14-292083
www.weidmueller.com

Mating connector (fully pluggable)
BLA

Female header with clamping yoke connection system. The principle of the vibration-proof screw connection and the Unimate range pin arrangement provides a unique security during operation. Also available with dovetail (B) for convenient attachment of fixing blocks. The BLA has a labelling panel and can be coded. Supplied in cardboard box.

- 0.20 - 2.5mm² (IEC) / 26 - 12 AWG (UL)
- 400 V (IEC) / 300 V (UL)
- 17.5 A (IEC) / 10 A (UL)

General ordering data

Type	Order No.	Version	GTIN (EAN)	Qty.	Product data	Packaging
BLA 8 SN OR	1282360000	PCB plug-in connector, female plug, 5.08 mm, No. of poles: 8, 180°, Clamping yoke connection, Clamping range, rated connection, max.: 3.32 mm ² , Box	4008190173555	42 pc(s).	IEC: 400 V / 17.5 A / 0.2 - 2.5 mm ² UL: 300 V / 10 A / AWG 26 - AWG 12	Box

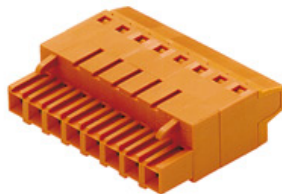
BLAT

Female connectors with TOP connection system enable the clamping screw to be tightened parallel with the wire and so result in a high connection density. Also available with dovetail (B) for convenient attachment of fixing blocks. The BLAT has a labelling panel and can be coded. Supplied in cardboard box.

- 0.20 - 2.5mm² (IEC) / 26 - 14 AWG (UL)
- 400 V (IEC) / 300 V (UL)
- 15 A (IEC) / 10 A (UL)

General ordering data

Type	Order No.	Version	GTIN (EAN)	Qty.	Product data	Packaging
BLAT 8 SN OR	1484860000	PCB plug-in connector, female plug, 5.08 mm, No. of poles: 8, 180°, TOP connection, Clamping range, rated connection, max.: 2.5 mm ² , Box	4008190028459	42 pc(s).	IEC: 400 V / 15 A / 0.2 - 2.5 mm ² UL: 300 V / 10 A / AWG 26 - AWG 14	Box

Recommended wave soldering profiles

Weidmüller Interface GmbH & Co. KG
 Klängenbergstraße 16
 D-32758 Detmold
 Germany
 Fon: +49 5231 14-0
 Fax: +49 5231 14-292083
 www.weidmueller.com

Single Wave:



Double Wave:



Wave soldering profiles

Wired connection elements should be processed in accordance with the DIN EN 61760-1 standard. We have included two recommendations for practical wave soldering profiles, with which Weidmüller PCB terminals and connectors are qualified.

When choosing a suitable profile for your application, the following factors also need to be considered:

- PCB thickness
- Proportion of Cu in the layers
- Single/double-sided assembly
- Product range
- Heating and cooling rates

The single and double wave profiles each indicate the recommended operating range, including the maximum soldering temperature of 260°C. In practice, the maximum soldering temperature is quite often well below the above maximum profile.

Adressen weltweit

Let's connect.

- AE Vereinigte Arabische Emirate**
Weidmüller Middle East FZE
Warehouse Q3-79
SAIF-Zone
P.O. BOX 8591
Sharjah
Telefonnummer +971 65572723
Faxnummer +971 65572724
wme.info@weidmueller.com
- AO Angola**
Bitte kontaktieren Sie
Phambili Interface
Südafrika
- AR Argentinien**
CPI SA
Bauness 2660
C1431DOF Buenos Aires
Telefonnummer +54 11 4523 8008
Faxnummer +54 11 4522 0546
info@cpi.com.ar
www.cpi.com.ar
- AT Österreich**
Weidmüller GmbH
IZ NOE Süd Straße 2b, Obj
M 59
2355 Wiener Neudorf
Telefonnummer +43 2236 67080
Faxnummer +43 2236 6708-899
office.at@weidmueller.com
www.weidmueller.com
- AU Australia**
Weidmüller Pty. Ltd.
PO BOX 6944
Huntingwood 2148
Huntingwood Drive 43
Huntingwood NSW 2148
Telefonnummer +61 2 9671 9999
Faxnummer +61 2 9671 9911
info@weidmuller.com.au
www.weidmuller.com.au
- AZ Aserbaidschan**
Repräsentanz Büro
Rashad Mahmudov
Demirchi Tower, 4th floor
37, Khojali ave.
AZ 1025 Baku
Telefonnummer +994 12 488 80 36
Faxnummer +994 12 488 80 37
rashad.mahmudov@weidmueller.com
- BA Bosnien und Herzegowina**
Bitte kontaktieren Sie
unser Representative Office
Weidmüller Interface GmbH
& Co. KG
Serbien

oder

BIG electric d.o.o
Mladena Stojanovića 117A
78000 Banja Luka
Telefonnummer +387 51926277
Faxnummer +387 51926277
bigelectric@blic.net
www.bigelectric.ba
- BE Belgien**
Weidmüller Benelux B. V.
Mechelsesteenweg 519 bus
6 an 7
1930 Nossegem
Telefonnummer +32 2 752 40 70
Faxnummer +32 2 751 36 06
info@weidmueller.be
www.weidmueller.be
- BG Bulgarien**
Weid-Bul EOOD
Bul. "Kliment Ohridski" 13
1756 Sofia
Telefonnummer +359 2 963 2560
Faxnummer +359 2 963 1098
sofia@weidbul.com
www.weidbul.com
- BH Bahrain**
Khayber Trading Company
P.O Box 1976
Manama
Telefonnummer +973 720747
Faxnummer +973 720331
khayber@batelco.com.bh
- BR Brasilien**
Weidmüller Conexel do Brasil
Conexões Elétricas Ltda.
Av. Presidente Juscelino, 642
- Piraporinha
Diadema, São Paulo
09950-370
Telefonnummer +55 (11) 4366-9600
Faxnummer +55 (11) 4362-1677
vendas@weidmueller.com.br
www.weidmueller.com.br
- BW Botswana**
Bitte kontaktieren Sie
Phambili Interface
Südafrika
- BY Weißrussland**
TECHNIKON Ltd.
Nezavisimosti pr. 177-9
220125 Minsk
Telefonnummer +375 17 393-11-77
Faxnummer +375 17 3930080
wm@technikon.by
- CA Kanada**
W Interconnections Canada
Inc.
10 Spy Court
Markham Ontario L3R 5H6
Telefonnummer +1 (905) 475-1507 Ext. 9836
Faxnummer +1 (905) 475-2798
support@weidmuller.ca
www.weidmuller.ca
- CG Kongo**
Bitte kontaktieren Sie
Phambili Interface
Südafrika
- CH Schweiz**
Weidmüller Schweiz AG
Rundbuckstraße 2
82 12 Neuhausen am
Rheinfall SH
Telefonnummer +41 52 674 07 07
Faxnummer +41 52 674 07 08
info@weidmueller.ch
www.weidmueller.ch
- CL Chile**
ATS- INTECH
Maria Luisa Santander 0475
Santiago
Providencia 7500859
Telefonnummer +56 2 341 1271
Faxnummer +56 2 341 1275
felipe@atsintech.com
www.atsintech.com

CPI CHILE LTDA
Av. Presidente Frei Montalva
6001, 47 complejo el cortijo
Santiago - Conchalí
Telefonnummer +562 963 8440
cpi@cpichile.cl
www.cpichile.cl
- CN China**
Weidmüller Interface
(Shanghai) Co. Ltd.
100 Yutong Road
25 F. BM Intercontinental
Business Center
200070 Shanghai
Telefonnummer +86 21-22195008
Faxnummer +86 512-68417505
customer.hotline@weidmueller.com.cn
www.cnweidmuller.com
- CO Kolumbien**
Automatización Avanzada
S. A.
Carrera 97 No., 24 c - 23
Bodega 4
110911 Bogotá-D.C.
Telefonnummer +57 (1) 547-8510
Faxnummer +57 (1) 422-3044
comercial@
automatizacionavanzada.com
www.
automatizacionavanzada.com
- CR Costa Rica**
ELVATRON S. A.
la Uruca 400 Norte Banco
Costa Rica
San Jose Costa Rica
Telefonnummer +506 2961-060
Faxnummer +506 5200-609
dirk.haese@elvatron.com
www.elvatron.com
- CZ Tschechische Republik**
Weidmüller s.r.o.
Lomnického 5/1705
140 00 Praha 4
Telefonnummer +420 244 001 400
Faxnummer +420 244 001 499
office@weidmueller.cz
www.weidmueller.cz
- DE Deutschland**
Weidmüller GmbH & Co. KG
Ohmstraße 9
32758 Detmold
Postfach 30 54
32720 Detmold
Telefonnummer +49 5231 1428-0
Faxnummer +49 5231 14-292083
weidmuller@weidmueller.de
www.weidmueller.de
- DK Dänemark**
Weidmüller Danmark
Vallensbækvej 18A
2605 Brøndby
Telefonnummer +45 27747800
kundeservice@weidmuller.dk
www.weidmuller.dk
- EC Ecuador**
Elsystec S. A., Electricidad
Sistemas y Tecnología
Vasco de Contreras N35-251
y Mañosa
Quito - Pichincha
Telefonnummer +593 22456510
Faxnummer +593 22456755
Elsystec@uiio.satnet.net
- EE Estland**
Bitte kontaktieren Sie
unser Representative Office
Weidmüller Interface GmbH
& Co. KG
Lettland

oder

Soots Interface OÜ
Pärnu mnt 142
11317 Tallinn
Telefonnummer +372 609 6933
Faxnummer
info@sootsinterface.ee
www.sootsinterface.ee
- EG Ägypten**
Standard Electric (OMEGA)
87, Mohamed Farid Street
Heliopolis
Cairo
Telefonnummer +202 26229000
Faxnummer +202 26221555
stdelec@rite.com
- ES Spanien**
Weidmüller, S. A.
Narcis Monturiol 11-13, Pol.
Ind. Sudoeste
8960 Sant Just
Desvern - Barcelona
Telefonnummer +34 934 803 386
Faxnummer +34 933 718 055
weidmuller@weidmuller.es
www.weidmuller.es
- FI Finnland**
Weidmüller Suomi,
Weidmüller Aktiebolagetin
sivuliike
Koy Plaza Vivace
Äyritie 8C
FI 15100 Vantaa
Telefonnummer +358 20 7351300
Faxnummer +358 800 114 667
asiakaspalvelu@weidmuller.fi
www.weidmuller.fi
- FR Frankreich**
Weidmüller E. U. R. L.
12, Chaussée Jules César
BP 263 Osny
95523 Cergy-Pontoise Cedex
Telefonnummer +33 1 34 24 55 00
Faxnummer +33 1 34 24 55 01
mail@weidmuller.fr
- GB Großbritannien**
Weidmüller Ltd.
Klippon House
Centurion Court Office Park,
Meridian East, Meridian
Business Park
Leicester
LE19 1TP
Telefonnummer +44 116 282 3470
Faxnummer +44 116 289 3582
marketing@weidmuller.co.uk
www.weidmuller.co.uk
- GE Georgien**
Bitte kontaktieren Sie
unser Representative Office
Rashad Mahmudov
Aserbaidschan.
- GR Griechenland**
G.A. Solutions
Ippokratous 11 Metamorfosi
144 52 Athen
Telefonnummer +30 210 2823233
Faxnummer +30 210 2823233
info@weidmuller.gr
www.weidmuller.gr
- GT Guatemala**
Prestelectro, Prestegard
Electro, S.A.
Avenida Petapa 44-22,
Zona 12
Guatemala City
Telefonnummer +502 2442-3346
Faxnummer +502 2476-8945
ventas@prestelectro.com
- HK Hong Kong**
Weidmüller (Hong Kong)
Limited Co. Ltd.
Unit 1617, Metropolis Tower
No. 10 Metropolis Drive,
Hunghom, Kowloon
Telefonnummer +852 3154 8088
Faxnummer +852 31548099
Info-hk@weidmueller.com.hk
- HR Kroatien**
ElektroPARTNER d.o.o.
Slavonska avenija 24/6
HR-10000 Zagreb
Telefonnummer +385 (1) 6184 793
Faxnummer +385 (1) 6184 795
elektropartner@zg.t-com.hr
www.elektropartner.hr
- HU Ungarn**
Weidmüller Kereskedelmi Kft.
Budapest
Gubacsi út 6.
1097
Telefonnummer +36 1 382 7700
Faxnummer +36 1 382 7701
info@weidmueller.hu
www.weidmueller.hu
- ID Indonesien**
PT. Nego Electrindo
Ruko Mega Grosir Cempaka
Mas Blok 1 No. 20 - 22
Jakarta 10640
Telefonnummer +62 21 42882255
Faxnummer +62 21 42882266
sales@negoelectrindo.co.id
- IE Irland**
Bitte kontaktieren Sie
Weidmüller Ltd.
Großbritannien
- IL Israel**
A. U. Shay Ltd.
23/25, Embar Street
49222 Petach-Tikva
P.O. Box 1 00 49
49222 Petach-Tikva
Telefonnummer +972 3-923-3601
Faxnummer +972 3-923-4601
shay@uriel-shay.com
www.uriel-shay.com
- ATEKA Ltd.**
4, Ha Tavor lane Industrial
area Segula
49691 Petach-Tikva
P.O. Box 4710
Petach-Tikva
Telefonnummer +972 73-200-1311
Faxnummer +972 3-924 4245
marketing@ateka.co.il
www.ateka.co.il
- IN Indien**
Repräsentanz Büro
Weidmüller Electronics India
Pvt. Ltd.
12th Lane North Avenue, Opp
Joggers Park,
Kalyani Nagar, Pune
411 006
Telefonnummer +91 20-41290090
wmi.pune@weidmueller.in
www.weidmueller.com
- IS Island**
Samey Automation Center
Lyngas 13
210 Garoabaer
Telefonnummer +354 510 5200
Faxnummer +354 5 10 5201
Samey@samey.is
www.samey.is
- IT Italien**
Weidmüller S. r.l.
Via Albert Einstein 4
20092 Cinisello
Balsamo Milano
Telefonnummer +39 02 660681
Faxnummer +39 02 6124945
weidmuller@weidmuller.it
www.weidmuller.it
- JM Jamaika**
Bitte kontaktieren Sie
W Interconnections Inc.
USA
- JO Jordanien**
Trans Jordan for Electro
PO Box 33 06 07
Amman
Telefonnummer +962 6 533 2020
Faxnummer +962 6 533 5800
transjordan@batelco.jo
- JP Japan**
Nihon Weidmüller Co. Ltd.
Sphere Tower Tennoz 2-2-8
Higashi-Shinagawa,
Shinagawa-ku
Tokyo
140-0002
Telefonnummer +81 3 6711 5300
Faxnummer +81 3 6711 5333
weidmullerjapan@weidmuller.com.jp
www.weidmuller.co.jp



Alle Weidmüller Adressen sowie Ihren lokalen Ansprechpartner finden Sie im Internet unter: www.weidmuller.com/countries

Vertriebsgesellschaft

Auslandsvertretung

ohne Auslandsvertretung

Let's connect.

- KE Kenia**
Bitte kontaktieren Sie Phambili Interface Südafrika
- KR Korea**
Weidmüller Korea Co. Ltd.
9th floor, Wonbang B/D
Samseong 2-Dong, Gangnam-Gu
Seoul 143-42
Telefonnummer +82 2-516-0003
Faxnummer +82 2-516-0090
info@weidmuller.co.kr
www.weidmuller.co.kr
- KW Kuwait**
Kana Controls General Trading & Contracting Co. W. L. L.
Al Rai Industrial Area, Plot 28-30, St. 31
13016 Safat
B.P. 25593
Telefonnummer +965 4741373
Faxnummer +965 4741537
info@kanacontrols.com
- KZ Kasachstan**
Bitte kontaktieren Sie OOO Weidmüller Russland
- LB Libanon**
Progress Engineering & Trading Enterprises
Al Nahr Street
Beirut 11-1111
Telefonnummer +961 1 444 664
Faxnummer +961 1 561 880
progress@inco.com.lb
- LT Litauen**
Bitte kontaktieren Sie unser Representative Office Weidmüller Interface GmbH & Co. KG Lettland
oder
ELEKTROS IRANGA
Tinklu g. 29 a
LT-5319 Panevezys
Telefonnummer +370 (45) 582 828
Faxnummer
info@eliranga.lt
- LU Luxemburg**
Bitte kontaktieren Sie Weidmüller Benelux B. V. Niederlande
- LV Lettland**
SIA Abi4
Daugavgrivas 31b
Riga, LV-1007
Telefonnummer +371 674 70999
Faxnummer +371 676 24562
abi_4@tvnet.lv
Repräsentanz Büro
Weidmüller Interface GmbH & Co. KG
Udens str. 12-118
Riga, LV-1007
Telefonnummer +371 29254766
Faxnummer +371 674 65637
lgonis.rudaks@weidmueller.com
www.weidmueller.com
- MD Moldawien**
BERHORD A & D srl
79/1, str. Milescu Spartaru
MD-2075 Chisinau
Moldova
Telefonnummer +373 (22) 815002
Faxnummer +373 (22) 815007
atiuleanu@berhord.com
www.ad.berhord.com
- ME Montenegro**
Bitte kontaktieren Sie unser Representative Office Weidmüller Interface GmbH & Co. KG Serbien.
- MG Madagaskar**
Bitte kontaktieren Sie Phambili Interface Südafrika
- MK Mazedonien**
Bitte kontaktieren Sie unser Representative Office Weidmüller Interface GmbH & Co. KG Serbien
oder
ELEKTRO - SMK doool
UL. III Makedonska brigada
b.b.
1000 Skopje
Telefonnummer +389 22460295
Faxnummer
Elektro-smk@telekabel.net.mk
- MT Malta**
E. S. S., Electrical Supplies & Services Ltd.
San Gwakklin Road
Mriehel
Telefonnummer +356 21255777
Faxnummer +356 21255999
robert.agius@ess.com.mt
- MU Mauritius**
Mubelo Electrical Ltd.
Office 26, Gateway building,
St Jean Road
Quatre Bornes
Mauritius
Telefonnummer +230 4670989
Faxnummer +230 4654051
richard.mubelo@orange.mu
- MW Malawi**
Bitte kontaktieren Sie Phambili Interface Südafrika
- MX Mexiko**
W Interconnections S. A.
DE C. V.
Blvd. Hermanos Serdán 698,
Col. San Rafael Oriente
72029 Puebla
Telefonnummer +52 (222) 268 6227
Faxnummer +52 (222) 286 6242
clientes@weidmuller.com.mx
- MY Malaysia**
Connect Plus Technology Sdn Bhd
No. 43, Jalan PJS 11/22,
Bandar Sunway
46150 Petaling Jaya
Selangor Darul Ehsan
Telefonnummer +60 3 5633 7363
Faxnummer +60 3 5633 6562
paul@cptech.com.my
www.cptech.com.my
- MZ Mosambik**
Bitte kontaktieren Sie Phambili Interface Südafrika
- NA Namibia**
Bitte kontaktieren Sie Phambili Interface Südafrika
- NG Nigeria**
Bitte kontaktieren Sie
- NL Niederlande**
Weidmüller Benelux B. V.
Franciscusweg 221
1216 SE Hilversum
Postfach 1505
1200 BM Hilversum
Telefonnummer +31 35 626 12 61
Faxnummer +31 35 623 20 44
info@weidmuller.nl
www.weidmuller.nl
- NO Norwegen**
Sivilingeniør J.F. Knudtzen AS
Billingstadsletta 97
1396 Billingstad
PO Box 160
1378 Nesbru
Telefonnummer +47 66 98 33 50
Faxnummer +47 66 98 09 55
firmapost@jfknuudtzen.no
www.jfknuudtzen.no
- NZ Neuseeland**
Cuthbert S. Steward Ltd.
27 Te Puni Street
Petone
PO Box 38496
Wellington Mail Centre 5054
Telefonnummer (04) 568 6156
Faxnummer (09) 489 1752
csl@cuthbertsteward.co.nz
Cuthbert S. Steward Ltd
4 Fred Thomas Drive
Aon Building, Ground Floor,
South Entry
Takapuna
PO Box 100 338
North Shore City 745
Telefonnummer (09) 489 1751
Faxnummer (04) 568 6056
cslak@cuthbertsteward.co.nz
- OM Oman**
DAN INTERNATIONAL LLC.
Ghala St. 111
BP 2901
Seeb
Telefonnummer +968 5036 77
Faxnummer +968 5037 55
yedu@danintl.com
- PE Peru**
IMPEXINCA S.A.C.
Calle Ortiz de Zevallos No.
105, Urb. San Antonio
18
Lima, Miraflores
Telefonnummer +51 1 447 5608
info@impexinca.pe
www.impexinca.pe
J & W CIA. S. A.
Calle 6 Mz. D Lte. 23, Urb.
Ind. Grimanesa
01
Callao
Telefonnummer +51 1 572 2539
Faxnummer +51 1 572 0152
contacto@jwcia.com
www.jwcia.com
- PH Philippinen**
Enclosure Systems Specialists Inc.
2276 Don Chino Roces
Avenue Extension
Room 103/105 Narra Building
1231 Makati City
Telefonnummer +63 2 813 8580
Faxnummer +63 2 813 8596
sales_encsys@pltdsl.net
www.enclosuresystemsph.com
- PK Pakistan**
Automation Controls (Pak)
Apartment No. 33 C III,
Chenab Block, Allama Iqbal
Town
Lahore
Telefonnummer +92 42 37809948
Faxnummer +92 42 37809950
nadeem@acpак.com.pk
www.acpак.com.pk
- PL Polen**
Weidmüller Sp. z o. o.
ul. Ogrodowa 58
00-876 Warszawa
Telefonnummer +48 22 510 09 40
Faxnummer +48 22 510 09 41
biuro@weidmuller.com.pl
www.weidmuller.pl
- PR Puerto Rico**
Bitte kontaktieren Sie W Interconnections Inc. USA
- PT Portugal**
Weidmüller Sistemas de Interface S. A.
Estrada Outeiro Polima, R.
Augusto Dias da Silva, Lote B - Esc. 2
São Domingos de Rana
2785-515 Abóboda
Telefonnummer +351 214 459 191
Faxnummer +351 214 455 871
weidmuller@weidmuller.pt
www.weidmuller.pt
- PY Paraguay**
Bitte kontaktieren Sie CPI SA Argentinien
- QA Katar**
Petroleum Technology Co. W.L.L.
PO Box 16069
5th Floor Toyota tower
Telefonnummer +974 444 19603
Faxnummer +974 444 19604
petrotec@qatar.net.qa
www.petrotec.com.qa
- RO Rumänien**
Repräsentanz Büro
Weidmüller Interface GmbH & Co. KG
Ionescu Crum Street, No. 1, 1st Tower, 1st Floor,
Office 4
500446 Brasov - Brasov
Business Park
Telefonnummer +40 (268) 446 222
Faxnummer +40 (262) 205 410
claudiu.totea@weidmueller.com
www.weidmueller.com
- RS Serbien**
Repräsentanz Büro
Weidmüller Interface GmbH & Co. KG
Ustanička 189, III sprat
lokal 7a
11050 Beograd
Telefonnummer +381 112885274
Faxnummer +381 112885274
zoran.rabrenovic@weidmueller.com
TeLa Elektrik d.o.o.
Ul. Dr. Drage Ljočić 6
Beograd
Telefonnummer +381 11 2772 850
office@tela.rs
www.tela.rs
- RU Russland**
OOO Weidmüller
Warschavskoye highway, 25
A, bld. 6
Moskau
117105
Telefonnummer +7 (495) 771-69-40
Faxnummer +7 (495) 771-69-41
Info@weidmueller.ru
www.weidmueller.ru
- SA Saudi-Arabien**
Al Abdulkarim Holding Co.
P.O. Box 4
Dammam 31411
Telefonnummer +966 3 8337110
Faxnummer +966 3 8829547
E-Mail salehsk@akh.com.sa
www.weidmueller.ae
Saudi Electric Supply Company (SESCO)
P.O. Box 32 98
Al Khobar 31952
Telefonnummer +966 3 8829546 Ext. 3030
Faxnummer
E-Mail Safdar.Malik@sescogex.com
www.sesco-gex.com
- SE Schweden**
Weidmüller AB
Axel Danielssons väg 271
BOX 3 1025
SE-200 49 Malmö
Telefonnummer +46 77-143 00 44
Faxnummer +46 40-37 48 60
info@weidmuller.se
www.weidmuller.se
- SG Singapur**
Weidmüller Pte. Ltd.
70 Bendemeer Road
04-03 Luzerne Building
Singapore 339940
Telefonnummer +65 6841 5311
Faxnummer +65 6841 5377
info@weidmuller.com.sg
www.weidmuller.com.sg
- SI Slowenien**
Elektrospoj d. o. o.
Stegne 27
SI-1000 Ljubljana
Oreodnjelosvenska
Telefonnummer +386 1 511 3810
Faxnummer +386 1 511 1604
info@elektrospoj.si
www.elektrospoj.si
- SK Slowakei**
ELEKTRIS s.r.o.
Elektrárenská 1
831 04 Bratislava
Telefonnummer +421 2/4920 0113
Faxnummer +421 2/4920 0119
bratislava@elektris.sk
- SV El Salvador**
Prestegard Norte
11 Avenida Electro No. 240
Edificio Salazar No. 2
San Salvador
Telefonnummer +503 2271 1690
Faxnummer +503 2221 3851
prestegard@navegante.com.sv
- SY Syrien**
Bitte kontaktieren Sie Weidmüller Middle East FZE Vereinigte Arabische Emirate
- SZ Swasiland**
Bitte kontaktieren Sie Phambili Interface Südafrika
- TH Thailand**
Pisanu Engineering Co. Ltd.
Kwang Dingaeng, Khet
Dingaeng
800/2 Soi Trakulsuk, Asoke-
dindaeng Road
Dindaeng, Bangkok
10400
Telefonnummer +66 2 248 2896
Faxnummer +662 105 6301
ecsales@pisanu.co.th
www.pisanu.co.th
Repräsentanz Büro
Weidmüller Pte. Ltd.
37/F, Sathorn Square Building
98 North Sathorn Road
Bangkok, Silom Bangrak
10500
Telefonnummer +66 2 105 6300
Faxnummer +66 2 642 9220
info@weidmuller.com.sg
- TN Tunesien**
Bitte kontaktieren Sie Weidmüller E. U. R. L. Frankreich
- TR Türkei**
Weidmüller Elektronik Ticaret Ltd. Sirketi
Kavacik Mah. Orhan Veli Kanik
Cadidesi 9/1
34810 Beykoz / Istanbul
Telefonnummer +90 (216) 537 10 70
Faxnummer +90 (216) 537 10 77
info@weidmuller.com.tr
www.weidmuller.com.tr

Adressen weltweit

Let's connect.

TW Taiwan
Weidmuller (Hong Kong)
Limited
No. 3, Lane 89, ChungYang
N. Rd.
24148 SanChuang City,
Taipei
Telefonnummer +886 921
949 751
roy.lin@weidmueller.com.hk

TZ Tansania
Bitte kontaktieren Sie
Phambili Interface
Südafrika

UA Ukraine
LLC WM UKRAINE
Levanevskogo str. 6
Kiev
3058
Telefonnummer +38 044
490 32 48
Faxnummer
info@wm-ua.com.ua
wm-ua.com.ua/

Repräsentanz Büro
Weidmueller Interface GmbH
& Co. KG
Z. office 303
7-D, Zdolbunivska str.
Kiev, 2081
Telefonnummer (Mobil) +38
050 440 25 24
info.ua@weidmueller.com

US USA
W Interconnections Inc.
821 Southlake Boulevard
Richmond Virginia 23236
Telefonnummer +1 (804)
794-2877
Faxnummer +1 (804) 379-
2593
info@weidmuller.com
www.weidmuller.com

UY Uruguay
REWO Uruguay S. A.
AV. Bolivia 2001Esq
Rocafuerte
11300 Carrasco Montevideo
Telefonnummer +598 2604
8439
Faxnummer +598 2604
8439
rewo@rewoouruguay.com.uy

UZ Usbekistan
Bitte kontaktieren Sie
OOO Weidmüller
Russland

VE Venezuela
Somerinca C. A.
Corazon de Jesus - 3ra
Transversal con calle el
Carmen- Los Dos Caminos
Caracas 1070-A
Telefonnummer +58
2122352748
Faxnummer +58
2122399341
klocmoeller@cantv.net
www.somerinca.com

VN Vietnam
AUMI Industrial Equipment &
Automation Company Limited
E1, La Thanh Hotel
218 Doi Can Street
Lieu Giai Ward, Ba Dinh
District
Hanoi City
Telefonnummer +84 4
37628601
Faxnummer +84 4
62661391
aumi@aumi.com.vn
www.aumi.com.vn

Repräsentanz Büro
Weidmüller Pte. Ltd.
Level 16 Saigon Tower
Building
29 Le Duan Street
District 1
Ho Chi Minh
Telefonnummer +848 3520
7717
Faxnummer +848 3520
7604
info@weidmuller.com.sg

ZA Südafrika
Phambili Interface
PO Box 193
1609 Johannesburg, Edenvale
5 Bundo Road, Sebenza
1610 Johannesburg
Telefonnummer +27 (11)
4521930
Faxnummer
info@weidmuller.co.za
www.weidmuller.co.za

ZM Sambia
Bitte kontaktieren Sie
Phambili Interface
Südafrika

ZW Simbabwe
Bitte kontaktieren Sie
Phambili Interface
Südafrika